

R&S® Universal Radio Network Analyzer

R&S® TSMW

R&S® TSMF

Operating Manual

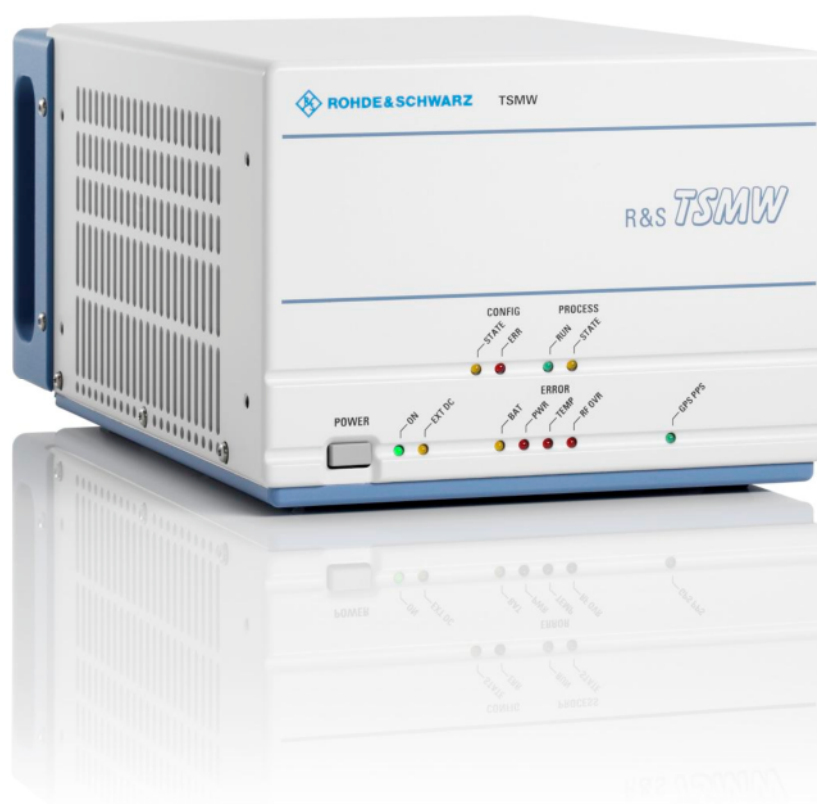

1171.5960.32 – 05

The Operating Manual describes the following R&S® Universal Radio Network Analyzer models and options:

- R&S® TSMW Universal Radio Network Analyzer (1503.3001.03)
- R&S® TSMF Universal Radio Network Analyzer (1503.3001.04)
- Options:
 - R&S® TSMW-K1 R&S® ROMES Digital IQ Interface(1503.3960.02)
 - R&S® TSMW-K21 R&S® ROMES GSM & WCDMA Scan Option (1503.4514.02)
 - R&S® TSMW-K22 R&S® ROMES CDMA2000 & EV-DO Scan Option (1503.4520.02)
 - R&S® TSMW-K26 R&S® ROMES TETRA Scan Option (1510.8792.02)
 - R&S® TSMW-K26Q ROMES TEDS Scan Option 1510.8792.02
 - R&S® TSMW-K27 R&S® ROMES Spectrum Scan Option (1503.4537.02)
 - R&S® TSMW-K28 R&S® ROMES WiMAX Scan Option (1503.4543.02)
 - R&S® TSMW-K29 R&S® ROMES LTE Scan Option (1503.4550.02)
 - R&S® TSMW-K30 LTE MIMO Option (1514.4085.02)
 - R&S® TSMW-B1 R&S® Digital I/Q Interface (1514.4004.02)

The firmware of the instrument makes use of several valuable open source software packages. the most important of them are listed below, together with their corresponding open source license. The verbatim license texts are provided on the user documentation CD-ROM (included in delivery).

Package	Link	License
OpenSSL	http://www.openssl.org/	OpenSSL / SSLeay

Rohde&Schwarz would like to thank the open source community for their valuable contribution to embedded computing.

© 2011 Rohde & Schwarz GmbH & Co. KG
81671 Munich, Germany

Printed in Germany – Subject to change – Data without tolerance limits is not binding.

R&S® is a registered trademark of Rohde & Schwarz GmbH & Co. KG.

Trade names are trademarks of the owners.

The following abbreviations are used throughout this manual:

R&S® Universal Radio Network Analyzer is abbreviated as R&S Universal Radio Network Analyzer.

R&S® TSMW is abbreviated as R&S TSMW.

R&S® TSMF is abbreviated as R&S TSMF.

R&S® ROMES is abbreviated as R&S ROMES.

R&S® Digital I/Q Interface is abbreviated as R&S Digital I/Q Interface

R&S® Digital I/Q SW is abbreviated as R&S Digital I/Q SW

R&S® IQR is abbreviated as R&S IQR

Basic Safety Instructions

Always read through and comply with the following safety instructions!

All plants and locations of the Rohde & Schwarz group of companies make every effort to keep the safety standards of our products up to date and to offer our customers the highest possible degree of safety. Our products and the auxiliary equipment they require are designed, built and tested in accordance with the safety standards that apply in each case. Compliance with these standards is continuously monitored by our quality assurance system. The product described here has been designed, built and tested in accordance with the attached EC Certificate of Conformity and has left the manufacturer's plant in a condition fully complying with safety standards. To maintain this condition and to ensure safe operation, you must observe all instructions and warnings provided in this manual. If you have any questions regarding these safety instructions, the Rohde & Schwarz group of companies will be happy to answer them.

Furthermore, it is your responsibility to use the product in an appropriate manner. This product is designed for use solely in industrial and laboratory environments or, if expressly permitted, also in the field and must not be used in any way that may cause personal injury or property damage. You are responsible if the product is used for any purpose other than its designated purpose or in disregard of the manufacturer's instructions. The manufacturer shall assume no responsibility for such use of the product.











The product is used for its designated purpose if it is used in accordance with its product documentation and within its performance limits (see data sheet, documentation, the following safety instructions). Using the product requires technical skills and, in some cases, a basic knowledge of English. It is therefore essential that only skilled and specialized staff or thoroughly trained personnel with the required skills be allowed to use the product. If personal safety gear is required for using Rohde & Schwarz products, this will be indicated at the appropriate place in the product documentation. Keep the basic safety instructions and the product documentation in a safe place and pass them on to the subsequent users.

Observing the safety instructions will help prevent personal injury or damage of any kind caused by dangerous situations. Therefore, carefully read through and adhere to the following safety instructions before and when using the product. It is also absolutely essential to observe the additional safety instructions on personal safety, for example, that appear in relevant parts of the product documentation. In these safety instructions, the word "product" refers to all merchandise sold and distributed by the Rohde & Schwarz group of companies, including instruments, systems and all accessories. For product-specific information, see the data sheet and the product documentation.

Symbols and safety labels

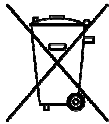
Symbol	Meaning	Symbol	Meaning
	Notice, general danger location Observe product documentation	○	ON/OFF supply voltage
	Caution when handling heavy equipment	⏻	Standby indication
	Danger of electric shock	— — —	Direct current (DC)

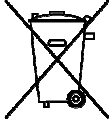
Basic Safety Instructions

Symbol	Meaning	Symbol	Meaning
	Warning! Hot surface		Alternating current (AC)
	Protective conductor terminal		Direct/alternating current (DC/AC)
	Ground		Device fully protected by double (reinforced) insulation
	Ground terminal		EU labeling for batteries and accumulators For additional information, see section "Waste disposal/Environmental protection", item 1.
	Be careful when handling electrostatic sensitive devices		EU labeling for separate collection of electrical and electronic devices For additional information, see section "Waste disposal/Environmental protection", item 2.
	Warning! Laser radiation For additional information, see section "Operation", item 7.		

Signal words and their meaning

The following signal words are used in the product documentation in order to warn the reader about risks and dangers.



Indicates an imminently hazardous situation which, if not avoided, will result in death or serious injury.



Indicates a potentially hazardous situation which, if not avoided, could result in death or serious injury.



Indicates a potentially hazardous situation which, if not avoided, could result in minor or moderate injury.



Indicates the possibility of incorrect operation which can result in damage to the product.

In the product documentation, the word ATTENTION is used synonymously.

These signal words are in accordance with the standard definition for civil applications in the European Economic Area. Definitions that deviate from the standard definition may also exist in other economic areas or military applications. It is therefore essential to make sure that the signal words described here are always used only in connection with the related product documentation and the related product. The use of signal words in connection with unrelated products or documentation can result in misinterpretation and in personal injury or material damage.

Basic Safety Instructions

Operating states and operating positions

The product may be operated only under the operating conditions and in the positions specified by the manufacturer, without the product's ventilation being obstructed. If the manufacturer's specifications are not observed, this can result in electric shock, fire and/or serious personal injury or death. Applicable local or national safety regulations and rules for the prevention of accidents must be observed in all work performed.

1. Unless otherwise specified, the following requirements apply to Rohde & Schwarz products: predefined operating position is always with the housing floor facing down, IP protection 2X, use only indoors, max. operating altitude 2000 m above sea level, max. transport altitude 4500 m above sea level. A tolerance of $\pm 10\%$ shall apply to the nominal voltage and $\pm 5\%$ to the nominal frequency, overvoltage category 2, pollution severity 2.
2. Do not place the product on surfaces, vehicles, cabinets or tables that for reasons of weight or stability are unsuitable for this purpose. Always follow the manufacturer's installation instructions when installing the product and fastening it to objects or structures (e.g. walls and shelves). An installation that is not carried out as described in the product documentation could result in personal injury or even death.
3. Do not place the product on heat-generating devices such as radiators or fan heaters. The ambient temperature must not exceed the maximum temperature specified in the product documentation or in the data sheet. Product overheating can cause electric shock, fire and/or serious personal injury or even death.

Electrical safety

If the information on electrical safety is not observed either at all or to the extent necessary, electric shock, fire and/or serious personal injury or death may occur.

1. Prior to switching on the product, always ensure that the nominal voltage setting on the product matches the nominal voltage of the AC supply network. If a different voltage is to be set, the power fuse of the product may have to be changed accordingly.
2. In the case of products of safety class I with movable power cord and connector, operation is permitted only on sockets with a protective conductor contact and protective conductor.
3. Intentionally breaking the protective conductor either in the feed line or in the product itself is not permitted. Doing so can result in the danger of an electric shock from the product. If extension cords or connector strips are implemented, they must be checked on a regular basis to ensure that they are safe to use.
4. If there is no power switch for disconnecting the product from the AC supply network, or if the power switch is not suitable for this purpose, use the plug of the connecting cable to disconnect the product from the AC supply network. In such cases, always ensure that the power plug is easily reachable and accessible at all times. For example, if the power plug is the disconnecting device, the length of the connecting cable must not exceed 3 m. Functional or electronic switches are not suitable for providing disconnection from the AC supply network. If products without power switches are integrated into racks or systems, the disconnecting device must be provided at the system level.
5. Never use the product if the power cable is damaged. Check the power cables on a regular basis to ensure that they are in proper operating condition. By taking appropriate safety measures and carefully laying the power cable, ensure that the cable cannot be damaged and that no one can be hurt by, for example, tripping over the cable or suffering an electric shock.

Basic Safety Instructions

6. The product may be operated only from TN/TT supply networks fuse-protected with max. 16 A (higher fuse only after consulting with the Rohde & Schwarz group of companies).
7. Do not insert the plug into sockets that are dusty or dirty. Insert the plug firmly and all the way into the socket provided for this purpose. Otherwise, sparks that result in fire and/or injuries may occur.
8. Do not overload any sockets, extension cords or connector strips; doing so can cause fire or electric shocks.
9. For measurements in circuits with voltages $V_{rms} > 30$ V, suitable measures (e.g. appropriate measuring equipment, fuse protection, current limiting, electrical separation, insulation) should be taken to avoid any hazards.
10. Ensure that the connections with information technology equipment, e.g. PCs or other industrial computers, comply with the IEC60950-1/EN60950-1 or IEC61010-1/EN 61010-1 standards that apply in each case.
11. Unless expressly permitted, never remove the cover or any part of the housing while the product is in operation. Doing so will expose circuits and components and can lead to injuries, fire or damage to the product.
12. If a product is to be permanently installed, the connection between the protective conductor terminal on site and the product's protective conductor must be made first before any other connection is made. The product may be installed and connected only by a licensed electrician.
13. For permanently installed equipment without built-in fuses, circuit breakers or similar protective devices, the supply circuit must be fuse-protected in such a way that anyone who has access to the product, as well as the product itself, is adequately protected from injury or damage.
14. Use suitable overvoltage protection to ensure that no overvoltage (such as that caused by a bolt of lightning) can reach the product. Otherwise, the person operating the product will be exposed to the danger of an electric shock.
15. Any object that is not designed to be placed in the openings of the housing must not be used for this purpose. Doing so can cause short circuits inside the product and/or electric shocks, fire or injuries.
16. Unless specified otherwise, products are not liquid-proof (see also section "Operating states and operating positions", item 1). Therefore, the equipment must be protected against penetration by liquids. If the necessary precautions are not taken, the user may suffer electric shock or the product itself may be damaged, which can also lead to personal injury.
17. Never use the product under conditions in which condensation has formed or can form in or on the product, e.g. if the product has been moved from a cold to a warm environment. Penetration by water increases the risk of electric shock.
18. Prior to cleaning the product, disconnect it completely from the power supply (e.g. AC supply network or battery). Use a soft, non-linting cloth to clean the product. Never use chemical cleaning agents such as alcohol, acetone or diluents for cellulose lacquers.

Operation

1. Operating the products requires special training and intense concentration. Make sure that persons who use the products are physically, mentally and emotionally fit enough to do so; otherwise, injuries or material damage may occur. It is the responsibility of the employer/operator to select suitable personnel for operating the products.

Basic Safety Instructions

2. Before you move or transport the product, read and observe the section titled "Transport".
3. As with all industrially manufactured goods, the use of substances that induce an allergic reaction (allergens) such as nickel cannot be generally excluded. If you develop an allergic reaction (such as a skin rash, frequent sneezing, red eyes or respiratory difficulties) when using a Rohde & Schwarz product, consult a physician immediately to determine the cause and to prevent health problems or stress.
4. Before you start processing the product mechanically and/or thermally, or before you take it apart, be sure to read and pay special attention to the section titled "Waste disposal/Environmental protection", item 1.
5. Depending on the function, certain products such as RF radio equipment can produce an elevated level of electromagnetic radiation. Considering that unborn babies require increased protection, pregnant women must be protected by appropriate measures. Persons with pacemakers may also be exposed to risks from electromagnetic radiation. The employer/operator must evaluate workplaces where there is a special risk of exposure to radiation and, if necessary, take measures to avert the potential danger.
6. Should a fire occur, the product may release hazardous substances (gases, fluids, etc.) that can cause health problems. Therefore, suitable measures must be taken, e.g. protective masks and protective clothing must be worn.
7. Laser products are given warning labels that are standardized according to their laser class. Lasers can cause biological harm due to the properties of their radiation and due to their extremely concentrated electromagnetic power. If a laser product (e.g. a CD/DVD drive) is integrated into a Rohde & Schwarz product, absolutely no other settings or functions may be used as described in the product documentation. The objective is to prevent personal injury (e.g. due to laser beams).
8. EMC classes (in line with CISPR 11)
Class A: Equipment suitable for use in all environments except residential environments and environments that are directly connected to a low-voltage supply network that supplies residential buildings.
Class B: Equipment suitable for use in residential environments and environments that are directly connected to a low-voltage supply network that supplies residential buildings.

Repair and service

1. The product may be opened only by authorized, specially trained personnel. Before any work is performed on the product or before the product is opened, it must be disconnected from the AC supply network. Otherwise, personnel will be exposed to the risk of an electric shock.
2. Adjustments, replacement of parts, maintenance and repair may be performed only by electrical experts authorized by Rohde & Schwarz. Only original parts may be used for replacing parts relevant to safety (e.g. power switches, power transformers, fuses). A safety test must always be performed after parts relevant to safety have been replaced (visual inspection, protective conductor test, insulation resistance measurement, leakage current measurement, functional test). This helps ensure the continued safety of the product.

Basic Safety Instructions

Batteries and rechargeable batteries/cells

If the information regarding batteries and rechargeable batteries/cells is not observed either at all or to the extent necessary, product users may be exposed to the risk of explosions, fire and/or serious personal injury, and, in some cases, death. Batteries and rechargeable batteries with alkaline electrolytes (e.g. lithium cells) must be handled in accordance with the EN 62133 standard.

1. Cells must not be taken apart or crushed.
2. Cells or batteries must not be exposed to heat or fire. Storage in direct sunlight must be avoided. Keep cells and batteries clean and dry. Clean soiled connectors using a dry, clean cloth.
3. Cells or batteries must not be short-circuited. Cells or batteries must not be stored in a box or in a drawer where they can short-circuit each other, or where they can be short-circuited by other conductive materials. Cells and batteries must not be removed from their original packaging until they are ready to be used.
4. Cells and batteries must not be exposed to any mechanical shocks that are stronger than permitted.
5. If a cell develops a leak, the fluid must not be allowed to come into contact with the skin or eyes. If contact occurs, wash the affected area with plenty of water and seek medical aid.
6. Improperly replacing or charging cells or batteries that contain alkaline electrolytes (e.g. lithium cells) can cause explosions. Replace cells or batteries only with the matching Rohde & Schwarz type (see parts list) in order to ensure the safety of the product.
7. Cells and batteries must be recycled and kept separate from residual waste. Rechargeable batteries and normal batteries that contain lead, mercury or cadmium are hazardous waste. Observe the national regulations regarding waste disposal and recycling.

Transport

1. The product may be very heavy. Therefore, the product must be handled with care. In some cases, the user may require a suitable means of lifting or moving the product (e.g. with a lift-truck) to avoid back or other physical injuries.
2. Handles on the products are designed exclusively to enable personnel to transport the product. It is therefore not permissible to use handles to fasten the product to or on transport equipment such as cranes, fork lifts, wagons, etc. The user is responsible for securely fastening the products to or on the means of transport or lifting. Observe the safety regulations of the manufacturer of the means of transport or lifting. Noncompliance can result in personal injury or material damage.
3. If you use the product in a vehicle, it is the sole responsibility of the driver to drive the vehicle safely and properly. The manufacturer assumes no responsibility for accidents or collisions. Never use the product in a moving vehicle if doing so could distract the driver of the vehicle. Adequately secure the product in the vehicle to prevent injuries or other damage in the event of an accident.

Waste disposal/Environmental protection

1. Specially marked equipment has a battery or accumulator that must not be disposed of with unsorted municipal waste, but must be collected separately. It may only be disposed of at a suitable collection point or via a Rohde & Schwarz customer service center.

Instrucciones de seguridad elementales

2. Waste electrical and electronic equipment must not be disposed of with unsorted municipal waste, but must be collected separately.
Rohde & Schwarz GmbH & Co. KG has developed a disposal concept and takes full responsibility for take-back obligations and disposal obligations for manufacturers within the EU. Contact your Rohde & Schwarz customer service center for environmentally responsible disposal of the product.
3. If products or their components are mechanically and/or thermally processed in a manner that goes beyond their intended use, hazardous substances (heavy-metal dust such as lead, beryllium, nickel) may be released. For this reason, the product may only be disassembled by specially trained personnel. Improper disassembly may be hazardous to your health. National waste disposal regulations must be observed.
4. If handling the product releases hazardous substances or fuels that must be disposed of in a special way, e.g. coolants or engine oils that must be replenished regularly, the safety instructions of the manufacturer of the hazardous substances or fuels and the applicable regional waste disposal regulations must be observed. Also observe the relevant safety instructions in the product documentation. The improper disposal of hazardous substances or fuels can cause health problems and lead to environmental damage.

For additional information about environmental protection, visit the Rohde & Schwarz website.

Instrucciones de seguridad elementales

¡Es imprescindible leer y cumplir las siguientes instrucciones e informaciones de seguridad!

El principio del grupo de empresas Rohde & Schwarz consiste en tener nuestros productos siempre al día con los estándares de seguridad y de ofrecer a nuestros clientes el máximo grado de seguridad. Nuestros productos y todos los equipos adicionales son siempre fabricados y examinados según las normas de seguridad vigentes. Nuestro sistema de garantía de calidad controla constantemente que sean cumplidas estas normas. El presente producto ha sido fabricado y examinado según el certificado de conformidad adjunto de la UE y ha salido de nuestra planta en estado impecable según los estándares técnicos de seguridad. Para poder preservar este estado y garantizar un funcionamiento libre de peligros, el usuario deberá atenerse a todas las indicaciones, informaciones de seguridad y notas de alerta. El grupo de empresas Rohde & Schwarz está siempre a su disposición en caso de que tengan preguntas referentes a estas informaciones de seguridad.













Además queda en la responsabilidad del usuario utilizar el producto en la forma debida. Este producto está destinado exclusivamente al uso en la industria y el laboratorio o, si ha sido expresamente autorizado, para aplicaciones de campo y de ninguna manera deberá ser utilizado de modo que alguna persona/cosa pueda sufrir daño. El uso del producto fuera de sus fines definidos o sin tener en cuenta las instrucciones del fabricante queda en la responsabilidad del usuario. El fabricante no se hace en ninguna forma responsable de consecuencias a causa del mal uso del producto.

Instrucciones de seguridad elementales



Se parte del uso correcto del producto para los fines definidos si el producto es utilizado conforme a las indicaciones de la correspondiente documentación del producto y dentro del margen de rendimiento definido (ver hoja de datos, documentación, informaciones de seguridad que siguen). El uso del producto hace necesarios conocimientos técnicos y ciertos conocimientos del idioma inglés. Por eso se debe tener en cuenta que el producto solo pueda ser operado por personal especializado o personas instruidas en profundidad con las capacidades correspondientes. Si fuera necesaria indumentaria de seguridad para el uso de productos de Rohde & Schwarz, encontraría la información debida en la documentación del producto en el capítulo correspondiente. Guarde bien las informaciones de seguridad elementales, así como la documentación del producto, y entréguelas a usuarios posteriores.

Tener en cuenta las informaciones de seguridad sirve para evitar en lo posible lesiones o daños por peligros de toda clase. Por eso es imprescindible leer detalladamente y comprender por completo las siguientes informaciones de seguridad antes de usar el producto, y respetarlas durante el uso del producto. Deberán tenerse en cuenta todas las demás informaciones de seguridad, como p. ej. las referentes a la protección de personas, que encontrarán en el capítulo correspondiente de la documentación del producto y que también son de obligado cumplimiento. En las presentes informaciones de seguridad se recogen todos los objetos que distribuye el grupo de empresas Rohde & Schwarz bajo la denominación de "producto", entre ellos también aparatos, instalaciones así como toda clase de accesorios. Los datos específicos del producto figuran en la hoja de datos y en la documentación del producto.

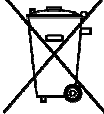
Símbolos y definiciones de seguridad

Símbolo	Significado	Símbolo	Significado
	Aviso: punto de peligro general Observar la documentación del producto		Tensión de alimentación de PUESTA EN MARCHA / PARADA
	Atención en el manejo de dispositivos de peso elevado		Indicación de estado de espera (standby)
	Peligro de choque eléctrico		Corriente continua (DC)
	Advertencia: superficie caliente		Corriente alterna (AC)
	Conexión a conductor de protección		Corriente continua / Corriente alterna (DC/AC)
	Conexión a tierra		El aparato está protegido en su totalidad por un aislamiento doble (reforzado)
	Conexión a masa		Distintivo de la UE para baterías y acumuladores Más información en la sección "Eliminación/protección del medio ambiente", punto 1.

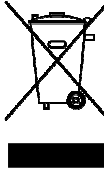
Instrucciones de seguridad elementales

Símbolo	Significado	Símbolo	Significado
	Aviso: Cuidado en el manejo de dispositivos sensibles a la electrostática (ESD)		Distintivo de la UE para la eliminación por separado de dispositivos eléctricos y electrónicos Más información en la sección "Eliminación/protección del medio ambiente", punto 2.
	Advertencia: rayo láser Más información en la sección "Funcionamiento", punto 7.		

Palabras de señal y su significado

En la documentación del producto se utilizan las siguientes palabras de señal con el fin de advertir contra riesgos y peligros.



PELIGRO identifica un peligro inminente con riesgo elevado que provocará muerte o lesiones graves si no se evita.



ADVERTENCIA identifica un posible peligro con riesgo medio de provocar muerte o lesiones (graves) si no se evita.



ATENCIÓN identifica un peligro con riesgo reducido de provocar lesiones leves o moderadas si no se evita.



AVISO indica la posibilidad de utilizar mal el producto y, como consecuencia, dañarlo.
En la documentación del producto se emplea de forma sinónima el término CUIDADO.

Las palabras de señal corresponden a la definición habitual para aplicaciones civiles en el área económica europea. Pueden existir definiciones diferentes a esta definición en otras áreas económicas o en aplicaciones militares. Por eso se deberá tener en cuenta que las palabras de señal aquí descritas sean utilizadas siempre solamente en combinación con la correspondiente documentación del producto y solamente en combinación con el producto correspondiente. La utilización de las palabras de señal en combinación con productos o documentaciones que no les correspondan puede llevar a interpretaciones equivocadas y tener por consecuencia daños en personas u objetos.

Estados operativos y posiciones de funcionamiento

El producto solamente debe ser utilizado según lo indicado por el fabricante respecto a los estados operativos y posiciones de funcionamiento sin que se obstruya la ventilación. Si no se siguen las indicaciones del fabricante, pueden producirse choques eléctricos, incendios y/o lesiones graves con posible consecuencia de muerte. En todos los trabajos deberán ser tenidas en cuenta las normas nacionales y locales de seguridad del trabajo y de prevención de accidentes.

Instrucciones de seguridad elementales

1. Si no se convino de otra manera, es para los productos Rohde & Schwarz válido lo que sigue: como posición de funcionamiento se define por principio la posición con el suelo de la caja para abajo, modo de protección IP 2X, uso solamente en estancias interiores, utilización hasta 2000 m sobre el nivel del mar, transporte hasta 4500 m sobre el nivel del mar. Se aplicará una tolerancia de ± 10 % sobre el voltaje nominal y de ± 5 % sobre la frecuencia nominal. Categoría de sobrecarga eléctrica 2, índice de suciedad 2.
2. No sitúe el producto encima de superficies, vehículos, estantes o mesas, que por sus características de peso o de estabilidad no sean aptos para él. Siga siempre las instrucciones de instalación del fabricante cuando instale y asegure el producto en objetos o estructuras (p. ej. paredes y estantes). Si se realiza la instalación de modo distinto al indicado en la documentación del producto, se pueden causar lesiones o, en determinadas circunstancias, incluso la muerte.
3. No ponga el producto sobre aparatos que generen calor (p. ej. radiadores o calefactores). La temperatura ambiente no debe superar la temperatura máxima especificada en la documentación del producto o en la hoja de datos. En caso de sobrecalentamiento del producto, pueden producirse choques eléctricos, incendios y/o lesiones graves con posible consecuencia de muerte.

Seguridad eléctrica

Si no se siguen (o se siguen de modo insuficiente) las indicaciones del fabricante en cuanto a seguridad eléctrica, pueden producirse choques eléctricos, incendios y/o lesiones graves con posible consecuencia de muerte.

1. Antes de la puesta en marcha del producto se deberá comprobar siempre que la tensión preseleccionada en el producto coincida con la de la red de alimentación eléctrica. Si es necesario modificar el ajuste de tensión, también se deberán cambiar en caso dado los fusibles correspondientes del producto.
2. Los productos de la clase de protección I con alimentación móvil y enchufe individual solamente podrán enchufarse a tomas de corriente con contacto de seguridad y con conductor de protección conectado.
3. Queda prohibida la interrupción intencionada del conductor de protección, tanto en la toma de corriente como en el mismo producto. La interrupción puede tener como consecuencia el riesgo de que el producto sea fuente de choques eléctricos. Si se utilizan cables alargadores o regletas de enchufe, deberá garantizarse la realización de un examen regular de los mismos en cuanto a su estado técnico de seguridad.
4. Si el producto no está equipado con un interruptor para desconectarlo de la red, o bien si el interruptor existente no resulta apropiado para la desconexión de la red, el enchufe del cable de conexión se deberá considerar como un dispositivo de desconexión. El dispositivo de desconexión se debe poder alcanzar fácilmente y debe estar siempre bien accesible. Si, p. ej., el enchufe de conexión a la red es el dispositivo de desconexión, la longitud del cable de conexión no debe superar 3 m). Los interruptores selectores o electrónicos no son aptos para el corte de la red eléctrica. Si se integran productos sin interruptor en bastidores o instalaciones, se deberá colocar el interruptor en el nivel de la instalación.
5. No utilice nunca el producto si está dañado el cable de conexión a red. Compruebe regularmente el correcto estado de los cables de conexión a red. Asegúrese, mediante las medidas de protección y de instalación adecuadas, de que el cable de conexión a red no pueda ser dañado o de que nadie pueda ser dañado por él, p. ej. al tropezar o por un choque eléctrico.

Instrucciones de seguridad elementales

6. Solamente está permitido el funcionamiento en redes de alimentación TN/TT aseguradas con fusibles de 16 A como máximo (utilización de fusibles de mayor amperaje solo previa consulta con el grupo de empresas Rohde & Schwarz).
7. Nunca conecte el enchufe en tomas de corriente sucias o llenas de polvo. Introduzca el enchufe por completo y fuertemente en la toma de corriente. La no observación de estas medidas puede provocar chispas, fuego y/o lesiones.
8. No sobrecargue las tomas de corriente, los cables alargadores o las regletas de enchufe ya que esto podría causar fuego o choques eléctricos.
9. En las mediciones en circuitos de corriente con una tensión $U_{\text{eff}} > 30 \text{ V}$ se deberán tomar las medidas apropiadas para impedir cualquier peligro (p. ej. medios de medición adecuados, seguros, limitación de tensión, corte protector, aislamiento etc.).
10. Para la conexión con dispositivos informáticos como un PC o un ordenador industrial, debe comprobarse que éstos cumplan los estándares IEC60950-1/EN60950-1 o IEC61010-1/EN 61010-1 válidos en cada caso.
11. A menos que esté permitido expresamente, no retire nunca la tapa ni componentes de la carcasa mientras el producto esté en servicio. Esto pone a descubierto los cables y componentes eléctricos y puede causar lesiones, fuego o daños en el producto.
12. Si un producto se instala en un lugar fijo, se deberá primero conectar el conductor de protección fijo con el conductor de protección del producto antes de hacer cualquier otra conexión. La instalación y la conexión deberán ser efectuadas por un electricista especializado.
13. En el caso de dispositivos fijos que no estén provistos de fusibles, interruptor automático ni otros mecanismos de seguridad similares, el circuito de alimentación debe estar protegido de modo que todas las personas que puedan acceder al producto, así como el producto mismo, estén a salvo de posibles daños.
14. Todo producto debe estar protegido contra sobretensión (debida p. ej. a una caída del rayo) mediante los correspondientes sistemas de protección. Si no, el personal que lo utilice quedará expuesto al peligro de choque eléctrico.
15. No debe introducirse en los orificios de la caja del aparato ningún objeto que no esté destinado a ello. Esto puede producir cortocircuitos en el producto y/o puede causar choques eléctricos, fuego o lesiones.
16. Salvo indicación contraria, los productos no están impermeabilizados (ver también el capítulo "Estados operativos y posiciones de funcionamiento", punto 1). Por eso es necesario tomar las medidas necesarias para evitar la entrada de líquidos. En caso contrario, existe peligro de choque eléctrico para el usuario o de daños en el producto, que también pueden redundar en peligro para las personas.
17. No utilice el producto en condiciones en las que pueda producirse o ya se hayan producido condensaciones sobre el producto o en el interior de éste, como p. ej. al desplazarlo de un lugar frío a otro caliente. La entrada de agua aumenta el riesgo de choque eléctrico.
18. Antes de la limpieza, desconecte por completo el producto de la alimentación de tensión (p. ej. red de alimentación o batería). Realice la limpieza de los aparatos con un paño suave, que no se deshilache. No utilice bajo ningún concepto productos de limpieza químicos como alcohol, acetona o diluyentes para lacas nitrocelulósicas.

Instrucciones de seguridad elementales

Funcionamiento

1. El uso del producto requiere instrucciones especiales y una alta concentración durante el manejo. Debe asegurarse que las personas que manejen el producto estén a la altura de los requerimientos necesarios en cuanto a aptitudes físicas, psíquicas y emocionales, ya que de otra manera no se pueden excluir lesiones o daños de objetos. El empresario u operador es responsable de seleccionar el personal usuario apto para el manejo del producto.
2. Antes de desplazar o transportar el producto, lea y tenga en cuenta el capítulo "Transporte".
3. Como con todo producto de fabricación industrial no puede quedar excluida en general la posibilidad de que se produzcan alergias provocadas por algunos materiales empleados —los llamados alérgenos (p. ej. el níquel)—. Si durante el manejo de productos Rohde & Schwarz se producen reacciones alérgicas, como p. ej. irritaciones cutáneas, estornudos continuos, enrojecimiento de la conjuntiva o dificultades respiratorias, debe avisarse inmediatamente a un médico para investigar las causas y evitar cualquier molestia o daño a la salud.
4. Antes de la manipulación mecánica y/o térmica o el desmontaje del producto, debe tenerse en cuenta imprescindiblemente el capítulo "Eliminación/protección del medio ambiente", punto 1.
5. Ciertos productos, como p. ej. las instalaciones de radiocomunicación RF, pueden a causa de su función natural, emitir una radiación electromagnética aumentada. Deben tomarse todas las medidas necesarias para la protección de las mujeres embarazadas. También las personas con marcapasos pueden correr peligro a causa de la radiación electromagnética. El empresario/operador tiene la obligación de evaluar y señalizar las áreas de trabajo en las que exista un riesgo elevado de exposición a radiaciones.
6. Tenga en cuenta que en caso de incendio pueden desprenderse del producto sustancias tóxicas (gases, líquidos etc.) que pueden generar daños a la salud. Por eso, en caso de incendio deben usarse medidas adecuadas, como p. ej. máscaras antigás e indumentaria de protección.
7. Los productos con láser están provistos de indicaciones de advertencia normalizadas en función de la clase de láser del que se trate. Los rayos láser pueden provocar daños de tipo biológico a causa de las propiedades de su radiación y debido a su concentración extrema de potencia electromagnética. En caso de que un producto Rohde & Schwarz contenga un producto láser (p. ej. un lector de CD/DVD), no debe usarse ninguna otra configuración o función aparte de las descritas en la documentación del producto, a fin de evitar lesiones (p. ej. debidas a irradiación láser).
8. Clases CEM (según CISPR 11)
Clase A: dispositivo apropiado para el uso en cualquier zona excepto en áreas residenciales y en aquellas zonas que se encuentran conectadas a una red de suministro de baja tensión que alimenta un edificio de viviendas.
Clase B: dispositivo apropiado para el uso en áreas residenciales y en aquellas zonas que se encuentran conectadas a una red de suministro de baja tensión que alimenta un edificio de viviendas.

Reparación y mantenimiento

1. El producto solamente debe ser abierto por personal especializado con autorización para ello. Antes de manipular el producto o abrirlo, es obligatorio desconectarlo de la tensión de alimentación, para evitar toda posibilidad de choque eléctrico.

Instrucciones de seguridad elementales

2. El ajuste, el cambio de partes, el mantenimiento y la reparación deberán ser efectuadas solamente por electricistas autorizados por Rohde & Schwarz. Si se reponen partes con importancia para los aspectos de seguridad (p. ej. el enchufe, los transformadores o los fusibles), solamente podrán ser sustituidos por partes originales. Después de cada cambio de partes relevantes para la seguridad deberá realizarse un control de seguridad (control a primera vista, control del conductor de protección, medición de resistencia de aislamiento, medición de la corriente de fuga, control de funcionamiento). Con esto queda garantizada la seguridad del producto.

Baterías y acumuladores o celdas

Si no se siguen (o se siguen de modo insuficiente) las indicaciones en cuanto a las baterías y acumuladores o celdas, pueden producirse explosiones, incendios y/o lesiones graves con posible consecuencia de muerte. El manejo de baterías y acumuladores con electrolitos alcalinos (p. ej. celdas de litio) debe seguir el estándar EN 62133.

1. No deben desmontarse, abrirse ni triturarse las celdas.
2. Las celdas o baterías no deben someterse a calor ni fuego. Debe evitarse el almacenamiento a la luz directa del sol. Las celdas y baterías deben mantenerse limpias y secas. Limpiar las conexiones sucias con un paño seco y limpio.
3. Las celdas o baterías no deben cortocircuitarse. Es peligroso almacenar las celdas o baterías en estuches o cajones en cuyo interior puedan cortocircuitarse por contacto recíproco o por contacto con otros materiales conductores. No deben extraerse las celdas o baterías de sus embalajes originales hasta el momento en que vayan a utilizarse.
4. Las celdas o baterías no deben someterse a impactos mecánicos fuertes indebidos.
5. En caso de falta de estanqueidad de una celda, el líquido vertido no debe entrar en contacto con la piel ni los ojos. Si se produce contacto, lavar con agua abundante la zona afectada y avisar a un médico.
6. En caso de cambio o recarga inadecuados, las celdas o baterías que contienen electrolitos alcalinos (p. ej. las celdas de litio) pueden explotar. Para garantizar la seguridad del producto, las celdas o baterías solo deben ser sustituidas por el tipo Rohde & Schwarz correspondiente (ver lista de recambios).
7. Las baterías y celdas deben reciclarse y no deben tirarse a la basura doméstica. Las baterías o acumuladores que contienen plomo, mercurio o cadmio deben tratarse como residuos especiales. Respete en esta relación las normas nacionales de eliminación y reciclaje.

Transporte

1. El producto puede tener un peso elevado. Por eso es necesario desplazarlo o transportarlo con precaución y, si es necesario, usando un sistema de elevación adecuado (p. ej. una carretilla elevadora), a fin de evitar lesiones en la espalda u otros daños personales.
2. Las asas instaladas en los productos sirven solamente de ayuda para el transporte del producto por personas. Por eso no está permitido utilizar las asas para la sujeción en o sobre medios de transporte como p. ej. grúas, carretillas elevadoras de horquilla, carros etc. Es responsabilidad suya fijar los productos de manera segura a los medios de transporte o elevación. Para evitar daños personales o daños en el producto, siga las instrucciones de seguridad del fabricante del medio de transporte o elevación utilizado.

Instrucciones de seguridad elementales

3. Si se utiliza el producto dentro de un vehículo, recae de manera exclusiva en el conductor la responsabilidad de conducir el vehículo de manera segura y adecuada. El fabricante no asumirá ninguna responsabilidad por accidentes o colisiones. No utilice nunca el producto dentro de un vehículo en movimiento si esto pudiera distraer al conductor. Asegure el producto dentro del vehículo debidamente para evitar, en caso de un accidente, lesiones u otra clase de daños.

Eliminación/protección del medio ambiente

1. Los dispositivos marcados contienen una batería o un acumulador que no se debe desechar con los residuos domésticos sin clasificar, sino que debe ser recogido por separado. La eliminación se debe efectuar exclusivamente a través de un punto de recogida apropiado o del servicio de atención al cliente de Rohde & Schwarz.
2. Los dispositivos eléctricos usados no se deben desechar con los residuos domésticos sin clasificar, sino que deben ser recogidos por separado.
Rohde & Schwarz GmbH & Co.KG ha elaborado un concepto de eliminación de residuos y asume plenamente los deberes de recogida y eliminación para los fabricantes dentro de la UE. Para desechar el producto de manera respetuosa con el medio ambiente, diríjase a su servicio de atención al cliente de Rohde & Schwarz.
3. Si se trabaja de manera mecánica y/o térmica cualquier producto o componente más allá del funcionamiento previsto, pueden liberarse sustancias peligrosas (polvos con contenido de metales pesados como p. ej. plomo, berilio o níquel). Por eso el producto solo debe ser desmontado por personal especializado con formación adecuada. Un desmontaje inadecuado puede ocasionar daños para la salud. Se deben tener en cuenta las directivas nacionales referentes a la eliminación de residuos.
4. En caso de que durante el trato del producto se formen sustancias peligrosas o combustibles que deban tratarse como residuos especiales (p. ej. refrigerantes o aceites de motor con intervalos de cambio definidos), deben tenerse en cuenta las indicaciones de seguridad del fabricante de dichas sustancias y las normas regionales de eliminación de residuos. Tenga en cuenta también en caso necesario las indicaciones de seguridad especiales contenidas en la documentación del producto. La eliminación incorrecta de sustancias peligrosas o combustibles puede causar daños a la salud o daños al medio ambiente.

Se puede encontrar más información sobre la protección del medio ambiente en la página web de Rohde & Schwarz.

Qualitätszertifikat

Certificate of quality

Certificat de qualité

Certified Quality System
ISO 9001

Certified Environmental System
ISO 14001

Sehr geehrter Kunde,

Sie haben sich für den Kauf eines Rohde&Schwarz-Produktes entschieden. Sie erhalten damit ein nach modernsten Fertigungsmethoden hergestelltes Produkt. Es wurde nach den Regeln unseres Qualitätsmanagementsystems entwickelt, gefertigt und geprüft. Das Rohde&Schwarz-Qualitätsmanagementsystem ist unter anderem nach ISO9001 und ISO14001 zertifiziert.

Der Umwelt verpflichtet

- Energie-effiziente, RoHS-konforme Produkte
- Kontinuierliche Weiterentwicklung nachhaltiger Umweltkonzepte
- ISO14001-zertifiziertes Umweltmanagementsystem

Dear customer,

You have decided to buy a Rohde&Schwarz product. You are thus assured of receiving a product that is manufactured using the most modern methods available. This product was developed, manufactured and tested in compliance with our quality management system standards. The Rohde&Schwarz quality management system is certified according to standards such as ISO9001 and ISO14001.

Environmental commitment

- Energy-efficient products
- Continuous improvement in environmental sustainability
- ISO14001-certified environmental management system

Cher client,

Vous avez choisi d'acheter un produit Rohde&Schwarz. Vous disposez donc d'un produit fabriqué d'après les méthodes les plus avancées. Le développement, la fabrication et les tests respectent nos normes de gestion qualité. Le système de gestion qualité de Rohde&Schwarz a été homologué, entre autres, conformément aux normes ISO9001 et ISO14001.

Engagement écologique

- Produits à efficience énergétique
- Amélioration continue de la durabilité environnementale
- Système de gestion de l'environnement certifié selon ISO14001





ROHDE & SCHWARZ

EC Certificate of Conformity



Certificate No.: 2011 – 01

This is to certify that:

Equipment type	Stock No.	Designation
TSMW	1503.3001.02 1503.3001.03 1503.3001.04	Radio Network Analyzer

complies with the provisions of the Directive of the Council of the European Union on the approximation of the laws of the Member States

- relating to electromagnetic compatibility (2004/108/EC)
- relating to radio interference of vehicles (72/245/EEC last adapted by 2009/19/EC)

Conformity is proven by compliance with the following standards:

EN 61326 - 1 : 2006
EN 61326 - 2 - 1 : 2006
EN 55011 : 2007 + A2 : 2007
EN 50498 : 2010

For the assessment of electromagnetic compatibility, the limits of radio interference for Class B equipment as well as the immunity to interference for operation in industry have been used as a basis.

ROHDE & SCHWARZ GmbH & Co. KG
Mühldorfstr. 15, D-81671 München

Munich, 2011-01-31

Central Quality Management GF-QP / Radde



이 기기는 가정용(B급) 전자파
적합기기로서 주로 가정에서
사용하는 것을 목적으로 하며,
모든 지역에서 사용할 수
있습니다

Customer Support

Technical support – where and when you need it

For quick, expert help with any Rohde & Schwarz equipment, contact one of our Customer Support Centers. A team of highly qualified engineers provides telephone support and will work with you to find a solution to your query on any aspect of the operation, programming or applications of Rohde & Schwarz equipment.

Up-to-date information and upgrades

To keep your instrument up-to-date and to be informed about new application notes related to your instrument, please send an e-mail to the Customer Support Center stating your instrument and your wish. We will take care that you will get the right information.

Europe, Africa, Middle East

Phone +49 89 4129 12345
customersupport@rohde-schwarz.com

North America

Phone 1-888-TEST-RSA (1-888-837-8772)
customer.support@rsa.rohde-schwarz.com

Latin America

Phone +1-410-910-7988
customersupport.la@rohde-schwarz.com

Asia/Pacific

Phone +65 65 13 04 88
customersupport.asia@rohde-schwarz.com

China

Phone +86-800-810-8228 /
+86-400-650-5896
customersupport.china@rohde-schwarz.com



Content

1.	System Overview and Operating Concept	5
	Introduction	5
	Feature Overview:.....	5
	R&S TSMF Special Solution	6
	General Setup	6
	Prerequisites.....	7
	System Requirements	8
2.	Setting up the Instrument	9
	Unpacking.....	9
	Mounting in a 19" Rack.....	9
3.	Front and Rear Panel Description	10
	Front Panel	10
	Rear Panel.....	14
4.	Safety Instructions	18
	General Precautions	18
	Protection against Electrostatics	18
	Cleaning the Outside and Storing	19
	EMC Safety Precautions.....	19
5.	Connecting the Instrument	20
	Connecting the Instrument to the External Devices	20
	Connecting the LAN Interface.....	22
	Dedicated Network Connection	22
	Non Dedicated Network Connection	27
	Connecting the Instrument to the DC Power Supply	28
	Different Power Cable Connections	29
6.	Switch On or OFF	30
	Switch On	30
	Switch OFF and Standby Mode	31
7.	Checking the Instrument.....	32
	Browser Application	32
	Recalling Instrument Setup.....	33

Overview Instrument Modes	34
Standby Mode.....	35
Idle Mode	35
Connected Mode	36
Measuring Mode	36
Boot / Self test Mode.....	36
System Warning	36
System Error.....	36
Application Event	36
8. Basic Instrument Functions	37
R&S TSMW-K1 Digital I/Q SW Option	38
Requirements for R&S TSMW-K1 (Matlab®).....	39
Requirements for R&S TSMW-K1 (C++)	39
Preparations	39
Matlab® Functions.....	39
R&S TSMW-B1 Digital I/Q Interface	40
Transfer Mode	40
Requirements for R&S TSMW-B1.....	40
Preparations	40
R&S ViCom Programming Interface	41
General	41
Requirements.....	41
Installation.....	41
Scan Options for R&S ROMES and ViCom.....	43
Requirements for R&S ROMES.....	43
Preparation for R&S ROMES.....	43
Requirements for R&S ViCom	43
R&S TSMW-K21 GSM & WCDMA Option	43
R&S TSMW-K22 CDMA2000® 1xEVDO Option.....	44
R&S TSMW-K26 TETRA Option for R&S ROMES	44
R&S TSMW-K27 RF Power Scan Option.....	44
R&S TSMW-K28 WiMAX Option.....	44
R&S TSMW-K29 LTE Option	45
GPS Standalone via USB	46
Example with Windows Hyper Terminal.....	49

9.	Installed SW	51
	Option Key	51
	Program Requirements to install the Option Key	51
	Software Options	51
	Installation of Software Options	51
	Ordering Additional Software Options	52
10.	Maintenance	53
	Firmware Update - TSMW	53
	Requirements	53
	Instructions FW Update via Web Browser	53
	Configure IP Settings	54
	Firmware Update – GPS Receiver	56
11.	Troubleshooting	57
	Identifying the Hardware Revision	57
	Self test of the RF chain	57
	Identifying Error State via Front Panel LEDs	58
	Guide to solving Instrument Connection Problems	60
	Troubleshooting via RS 232	62
	RS-232-C Output	62
	Tracing Power On Sequence	63
12.	Index	65

1. System Overview and Operating Concept

Introduction

The R&S Universal Radio Network Analyzer is a high-power platform for optimizing all conventional mobile radio networks. Two highly sensitive 20 MHz front ends for any input frequencies from 30 MHz to 6 GHz, a dual-channel preselector and an FPGA-based software-defined architecture offer unsurpassed performance while providing maximum flexibility and future proofness.

The R&S TSMW supports in addition to functioning as a scanner for wireless communications networks, digital I/Q data streaming. It is ideal for customer-specific applications. The R&S TSMF supports all functionality exclusive the digital I/Q data streaming functionality.

This manual describes both R&S Universal Radio Network Analyzer models.

Feature Overview:

- ◆ User-definable input frequency range from 30 MHz to 6 GHz
- ◆ Two independent RF and signal processing paths, each with a bandwidth of 20 MHz
- ◆ Integrated preselection for high intermodulation suppression together with high dynamic range
- ◆ Support of WiMAX IEEE802.16e measurements (R&S®TSMW-K28)
- ◆ Support of 3GPP LTE FDD & TD-LTE measurements (R&S®TSMW-K29)
- ◆ Support for 3GPP LTE MIMO measurements (TSMW-K30)
- ◆ Support of GSM and WCDMA measurements (R&S®TSMW-K21)
- ◆ Support of CDMA2000® and 1xEVDO measurements (R&S®TSMW-K22)
- ◆ Support of TETRA measurements (R&S®TSMW-K26)
- ◆ Support for TETRA2 (TEDS) measurement TSMW-K26Q
- ◆ Support of RF Power Scan (R&S®TSMW-K27)
- ◆ Support of position estimation of base stations together with R&S ROMES software (R&S ROMES option ROMES4LOC)
- ◆ Parallel measurements in GSM, WCDMA, CDMA2000® 1xEVDO, WiMAX™, LTE and TETRA networks
- ◆ ViCom programming interface for customer specific applications
- ◆ Future-proof software-defined architecture
- ◆ Embedded high sensitivity GPS receiver

Only for instrument R&S TSMW (Var03):

- ◆ I/Q streaming (R&S TSMW-K1) via:
 - ◆ R&S GigaBit Digital I/Q Interface (via LAN interface)
 - ◆ R&S Digital I/Q Interface (via R&S dedicated IQ interface - R&S TSMW-B1)

R&S TSMF Special Solution

The R&S TSMF is a special model of the R&S TSMW that does not permit any I/Q measurements with the R&S TSMW-K1 option. All other functions are fully available.

General Setup

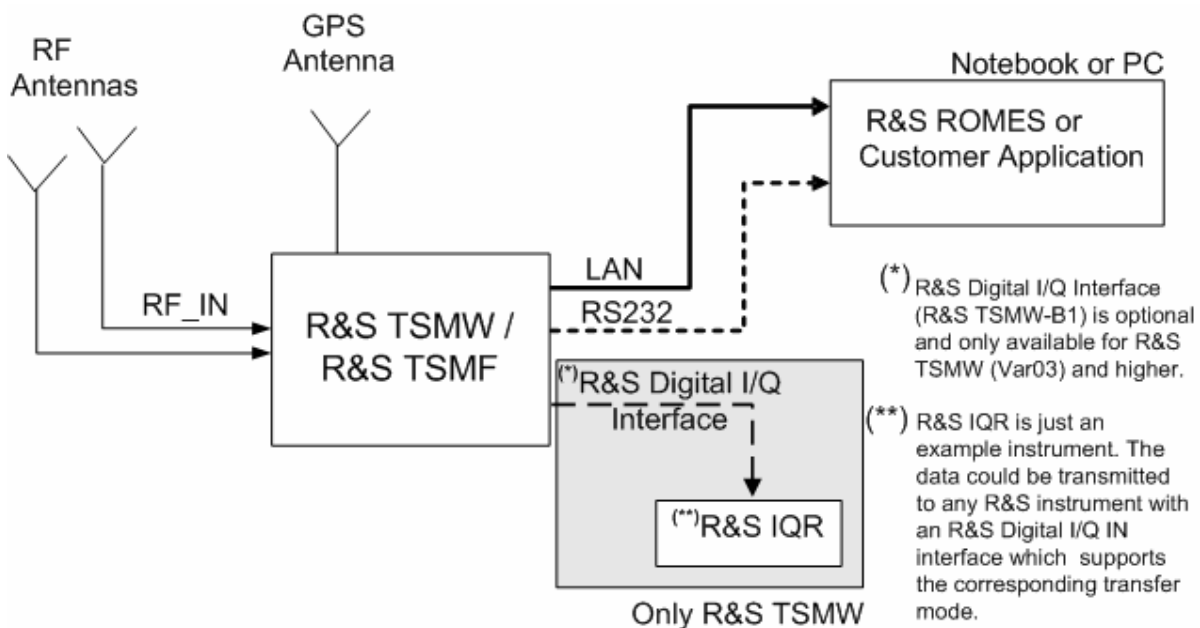

Figure 1-1: General Setup

There are three different possibilities for the host PC software to run and control the analyzer:

1. Applying the drive test software platform R&S ROMES (not part of this package!)
2. Utilizing the R&S ViCom programming interface package and integrate the analyzer as an OEM product into a customer specific software application.
3. Utilizing the R&S TSMW-K1 application. The application provides a flexible MATLAB interface as well as an equivalent C++ function interface for performing measurements directly on the R&S TSMW and processing the results over the GigaBit LAN interface or the R&S Digital I/Q Interface for post-processing - i.e. on the PC or recording on the R&S I/Q Data Recorder.

Prerequisites

To operate the analyzer correctly, you need the following equipment:

- | | |
|---|---|
| ◆ PC/notebook with LAN interface
(see System Requirements on page 8) | Not part of the package. |
| ◆ Antennas | GSM / UMTS magnetic mount antenna for UMTS / GSM / AMPS / GSM 1800 / GSM1900 with SMA→N adapter is part of the package. |
| ◆ Connection cables | Some cables are included (for details see Connecting the Instrument to the External Devices on page 20). |
| ◆ DC power supply | Optional part of the package: TSMW-Z1. |
| ◆ Necessary software options | Software options can be checked via the web browser (for details refer to Installed SW on page 51). |
| ◆ World wide adaptor for earthing type plug | Part of the package, necessary to use the TSMW-Z1 world wide. |
| ◆ R&S ROMES measurement software with appropriate analyzer software option(s) | Not part of the package. |
| respectively | |
| ◆ R&S ViCom Interface package for customer software | Part of this package. |



Please refer to the chapter [Software Options](#) on page 51 and to the Release Notes for information about the provided features for this version of the product.

System Requirements

Controlling and measuring with the analyzer requires a host controller in the form of a personal computer (PC) or notebook with LAN interface.

Requirements for the host controller

- ◆ Intel Pentium 4
- ◆ 2 GB Memory
- ◆ Windows XP SP3 / Windows 7
- ◆ PC: Dedicated Gbit LAN Adapter with Jumbo Frames 9kB and Flow Control Enabled
- ◆ Notebook: Dedicated Network Interface Card: PCIe

Requirements for I/Q baseband streaming with R&S TSMW-K1:

Only VAR02/VAR03

- ◆ Transfer Rate Hard disk: > 40 MB/sec
- ◆ Jumbo Frames 9kB and Flow Control enabled

For diagnostic purposes and servicing the analyzer, trace and diagnostic data see output via the serial RS-232-C interface of the instrument (see [Troubleshooting via RS 232](#)).

2. Setting up the Instrument

The following section describes the procedure for putting the instrument into operation. It contains general safety instructions for operation.

⚠ CAUTION

Device damage caused by disregarding the precautions!

Make sure instructions in the following sections are adhered in order to avoid danger to people and damage to the device. This is of particular importance when using the device for the first time. Also observe the general Safety Instructions at the beginning of this manual..

Unpacking

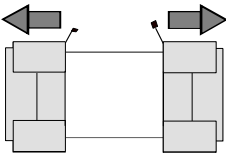

Remove protective covers

1. Remove the instrument from its packaging and check the equipment for completeness using the delivery list.
2. Remove the two protective covers from the front and rear panels of the instrument and carefully check the device for damage.
3. If the equipment is damaged, immediately contact the carrier who delivered the device. In this case, make sure that the box and packing material is not discarded.
4. Keep the box and packing material until you have verified that the contents are complete and the instrument has been tested electrically and mechanically.
5. The original packaging is also useful for transport or shipping of the instrument later on. Keep at least the two protective covers to prevent control elements and connectors from being damaged.

Mounting in a 19" Rack

Using the TSMW-Z3 rack adapter the instrument can be mounted in 19" racks according to the mounting instructions supplied with the rack adapter. To obtain the order number, please contact your local Rohde & Schwarz representative.

NOTICE

Danger of instrument damage!

Allow for sufficient air supply in the rack. Make sure that there is sufficient space between the ventilation holes and the rack casing.

3. Front and Rear Panel Description



R&S TSMW and R&S TSMF

The front and rear panel of the analyzer variants R&S TSMW and R&S TSMF are identical. The label on the front panel indicates the analyzer variant.

Front Panel

This section gives an overview of the control elements on the front panel of the analyzer. Each LED is briefly described. .

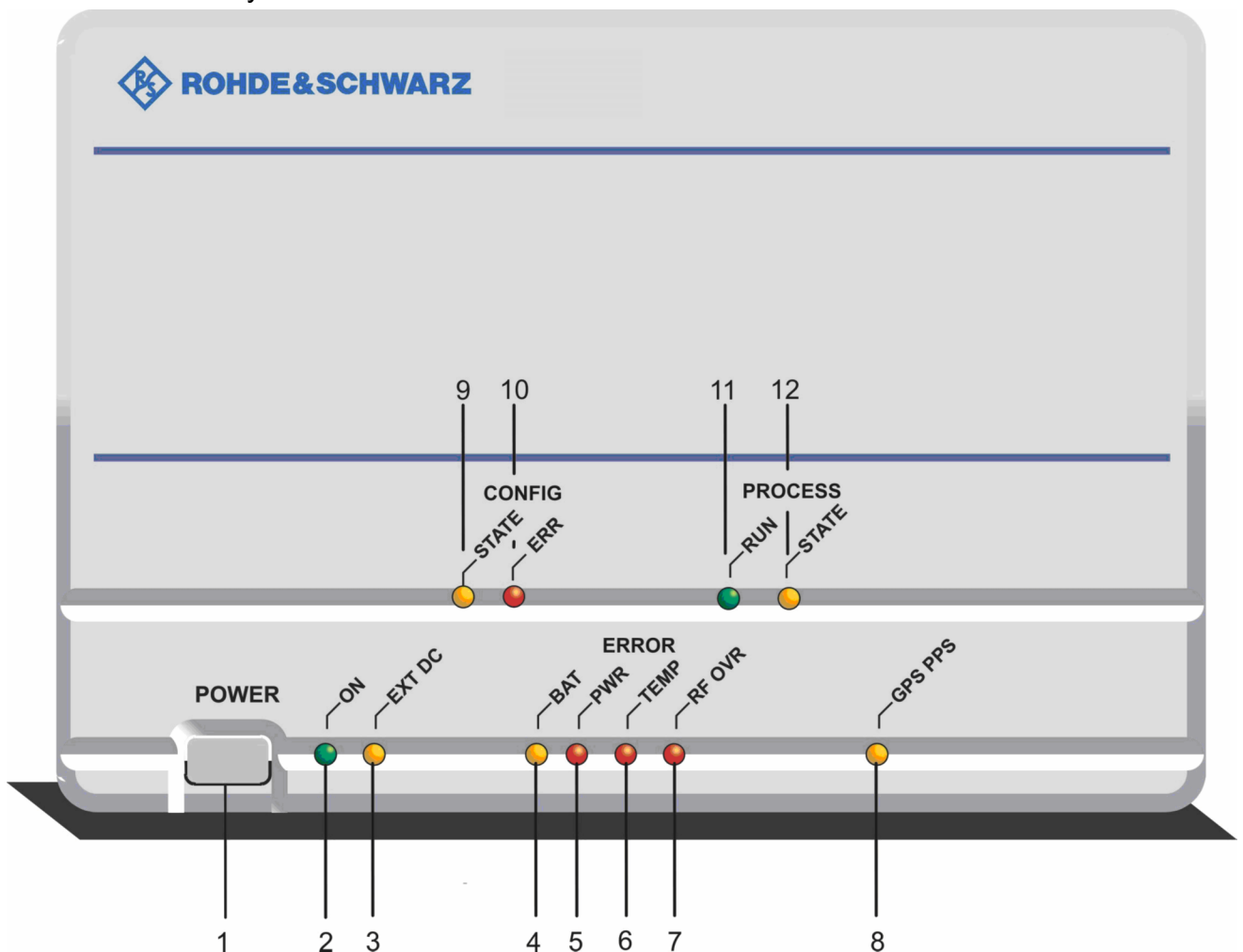
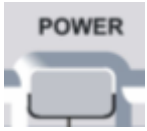

Figure 3-1: Front panel view

General

1 POWER Button



The Power Button switches the instrument on or off.

NOTICE**Danger of instrument damage!**

- ◆ The instrument must be set up in such a way that the operation of the power switch is not obstructed.
 - ◆ It is strongly recommended to shut down the operating system before switching off the instrument.
-

2 On - LED

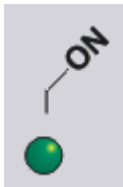

On: The instrument is in operating mode.
Flashing: Does not have any functionality.
Reserved for future use.

3 EXT DC - LED



On: The instrument is in standby mode but supplied with external power via the DC port at the rear panel.

The LED is also illuminated if the instrument is switched off i.e. it is in standby mode.

ERROR LEDs

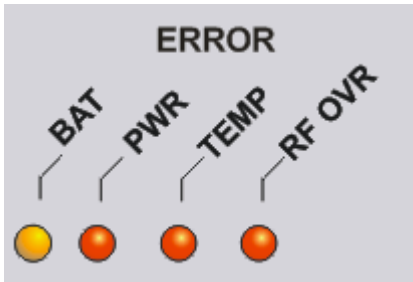

The Error LEDs indicate any failure in the system. The fault has to be diagnosed and resolved, if this is not possible stop measurements and contact R&S service.

4 ERR BAT - LED

Since R&S TSMW Var03 this LED is not used anymore.

5 ERR PWR - LED

On: At least one of the internal voltages is out of range.

This can damage the instrument and / or cause faulty measurements.

6 ERR TEMP - LED

On: System is overheated.

This can damage the instrument and / or cause faulty measurements.

7 ERR RF OVR - LED

On: Input of RF is too high.

Risk of fatal damage to the RF part of the instrument.

GPS

8 GPS PPS - LED

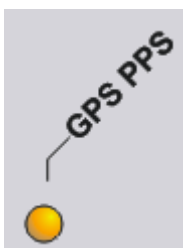

Flashing: The LED flashes once a second if the internal GPS delivers PPS (Pulse per Second) time sync signal.

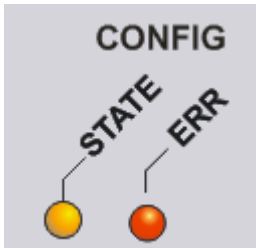
CONFIGURATION LEDs**9 CONFIGURATION STATE**

Indicate the internal FPGA configuration state.

Flashing: FPGA in process.

On: FPGA configuration finished.

For the different modes refer to [Figure 7-3: Modes and Interim States](#) on page 34.

10 CONFIGURATION ERROR

Flashing: No flashcard detected.

On: FPGA configuration files could not be read from flash.

If the configuration file cannot be loaded the system will shut down.

PROCESS LEDs**11 PROCESS RUN**

Indicate the operating mode of the instrument.

On: Connected Mode, device is configured for a specific measurement.

Off: Idle, device is booted, but not connected.

Flashing (slowly):

Measuring mode, measurement is running.

Flashing (fast):

Special application event, for future use.

12 PROC STATE – LED

On: Booting and self-test finished successfully.

Flashing (slowly):

System warning, minor problem detected.

Flashing (fast):

System error, major problem detected.

Rear Panel

This section gives an overview of the control elements and the connectors on the rear panel of the instrument. Each element or connector is briefly described and a reference is given to the chapters containing detailed information.

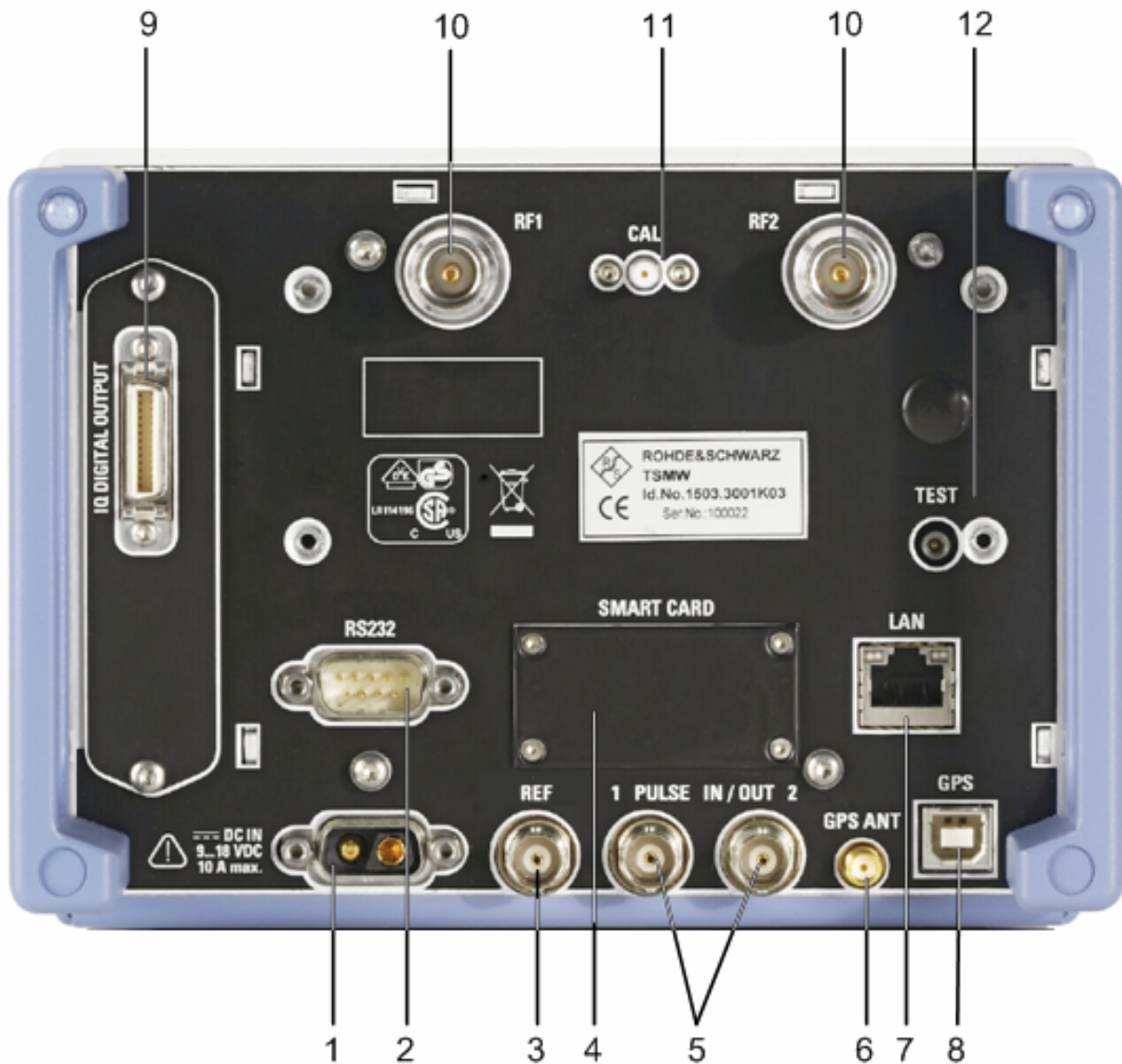

Figure 3-2: Rear panel view

1 DC IN

The instrument is supplied with an external power supply and a separate power cable.

Power supply:

Snap and lock jack, "2-pin" power supply input 9 V to 18 V DC with 10A max.

2 RS232

The RS232 serial port, 9-pin D-Sub (male) connector can be connected with the RS-232-C interface on the PC or notebook via a null-modem cable (necessary only for service purposes and troubleshooting).

NOTICE**Danger of instrument damage!**

Before switching on the instrument for the first time, check whether the correct DC supply voltage is present.

3 REF

Input/output for reference signal (SW controlled):

Output (Default):

- Output of internal 10 MHz reference signal (approx. sine wave / source impedance 50 R / output level ~ 0 dBm)

Input:

- Input for external 10 MHz reference (valid range: 0 to 10 dBm / input impedance 50R)

NOTE: if this connector is labeled "Ext. REF" then it is for reference signal input only (earlier TSMW models did not support the REF in/out feature).

4 Smart Card

Slot for Compact Flash Card.

**Warranty!**

Device will loose warranty if seal is broken.

5 PULSE IN/OUT 1 and 2

Input/output for configurable signals for triggering and control

Modes:

a) PPS IN: applied GPS PPS (Pulse per second) signal is used for synchronization

b) Trigger IN: applied trigger pulses used for cycle pulse recording (input 5V TTL, max. 200 Hz)

c) PPS out: output of internal PPS pulse of GPS receiver

NOTE: the functions listed above were introduced with FW 1.11

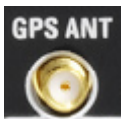
6 GPS ANT

SMA Connector for the external active or passive GPS antenna.

Antenna power: 3V max. 25mA

7 LAN

High speed Gigabit Ethernet interface with RJ 45 connector using IPv4.

8 GPS

This USB port can be used to output a GPS signal to an external device. The internal GPS is working as a standalone GPS instrument even if the instrument is not powered. Power supply for the GPS receiver will be done via the USB connection.

9 IQ Digital OUTPUT



R&S Digital I/Q Interface for R&S TSMW(Var03)

Output connector for digital I/Q data. An appropriate cable is not part of the package. Ask R&S for ordering information.

The interface is supported by many Rohde & Schwarz instruments.

10 RF 1 / RF2

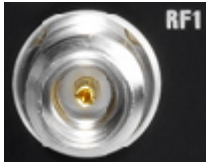

Input for the RF Signal.

N female, input impedance 50 Ω ,
VSWR type. 2.0

NOTICE

Danger of instrument damage!

Do not inject more than the maximum rated RF input power, otherwise, the input stage can be severely damaged.

Max. input power: +5dBm/ 0V DC

11 CAL



QMA input of carrier signal used for phase calibration of the two RF front ends (optional).

NOTICE

Danger of instrument damage!

In all operation modes of the instrument keep attention that no cable is connected with the CAL connector.

12 TEST

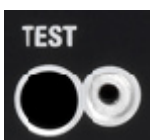

SMP port used for self test of the RF chain. Cable for test purposes is included in the delivery. Self test is not implemented. For future use.

4. Safety Instructions

General Precautions

⚠ CAUTION**Danger of instrument damage**

Any non-compliance with the following precautions may cause damage to the instrument. Prior to putting the device into operation, check the following:

- ◆ Make sure that the air can escape freely through the vents at the sides on the left and the right, i.e. allow a minimum 10 cm clearance.
- ◆ When using two instruments in a rack side by side a metal shield is required for air fluctuation.
- ◆ Make sure that the interfaces of the device are correctly connected.
- ◆ Make sure that the signal levels at the inputs and outputs do not exceed permissible limits.
- ◆ The device should only be operated in horizontal position on an even surface.
- ◆ The ambient temperature must not exceed the range specified in the data sheet.

Please also observe the instructions in the following sections and the general safety instructions at the beginning of this manual.

Protection against Electrostatics

**Risk of damaging the electronic components!**

To avoid damaging the electronic components of the EUT due to electrostatic discharge produced by contact, the use of appropriate protective measures is recommended.

Cleaning the Outside and Storing

Essentially necessary is the cleaning of the instrument.

NOTICE**Instrument damage caused by cleaning agents!**

- ◆ Cleaning agents contain substances that may damage the instrument, e.g. solvent-containing cleaning agents may damage the front panel labelling or plastic parts.
 - ◆ Never use cleaning agents such as solvents (thinners, acetone, etc.), acids, bases, or other substances.
 - ◆ The outside of the instrument is suitably cleaned using a soft, line-free dust cloth.
-

EMC Safety Precautions

To avoid electromagnetic interference (EMI) suitable, shielded signal and control cables must be used. Always operate the instrument when it is closed and with all shielding covers installed.

5. Connecting the Instrument

Connecting the Instrument to the External Devices

- ◆ Connect the PC or notebook LAN port to the LAN port of the analyzer. For detailed information see [Connecting the LAN Interface](#) on page 22.
- ◆ Connect the antenna SMA-connector to the SMA↔N adapter and connect the adapter to the RF IN connector. Two tri-band antennas with adapter are part of the package.

NOTICE**Danger of instrument damage!**

Do not to inject more than the maximum rated RF input power, otherwise the input stage could be severely damaged:

TSMW and TSMF: max. +5dBm, 0V (DC).

- ◆ Optional: Ext REF is only necessary if synchronization with a 10 MHz reference signal is used, required Input Level > 0dBm.
- ◆ Optional: The RS232 connector should be connected with the RS-232-C interface on the PC or notebook via a null-modem cable. This is necessary only for service purposes and troubleshooting; see [Troubleshooting via RS 232](#).
- ◆ Optional: Connect the GPS antenna to the GPS Antenna connector of the instrument for time synchronization to a GPS signal (3V, max.100mA for active antenna). Use of this function is strongly recommended as it improves time synchronization
- ◆ Optional: The GPS port is used for GPS standalone service via USB.
- ◆ Connect the instrument to the power supply. For detailed information see [Connecting the Instrument to the DC Power Supply](#) on page 28.
- ◆ Application specific: Additional multifunctional input or output connector PULSE IN/OUT 1 and 2 can be used for the connection to external equipment for different applications, for example distance trigger input used for distance triggered RF power scan measurements.
 - ◆ Input type: 3-5 V TTL, max +/- 12 V DC
 - ◆ Input type: 5 V TTL, Ri=100RNOTE: from firmware version 1.11 (and appropriate R&S ROMES resp. R&S ViCom Software) this may be used as an input for cycles pulse recording - PPS input / output

See [Figure 5-1](#) for the complete wiring diagram.

R&S TSMW can be powered from any of these three sources, for detailed descriptions refer to [Different Power Cable Connections](#) on page 23.

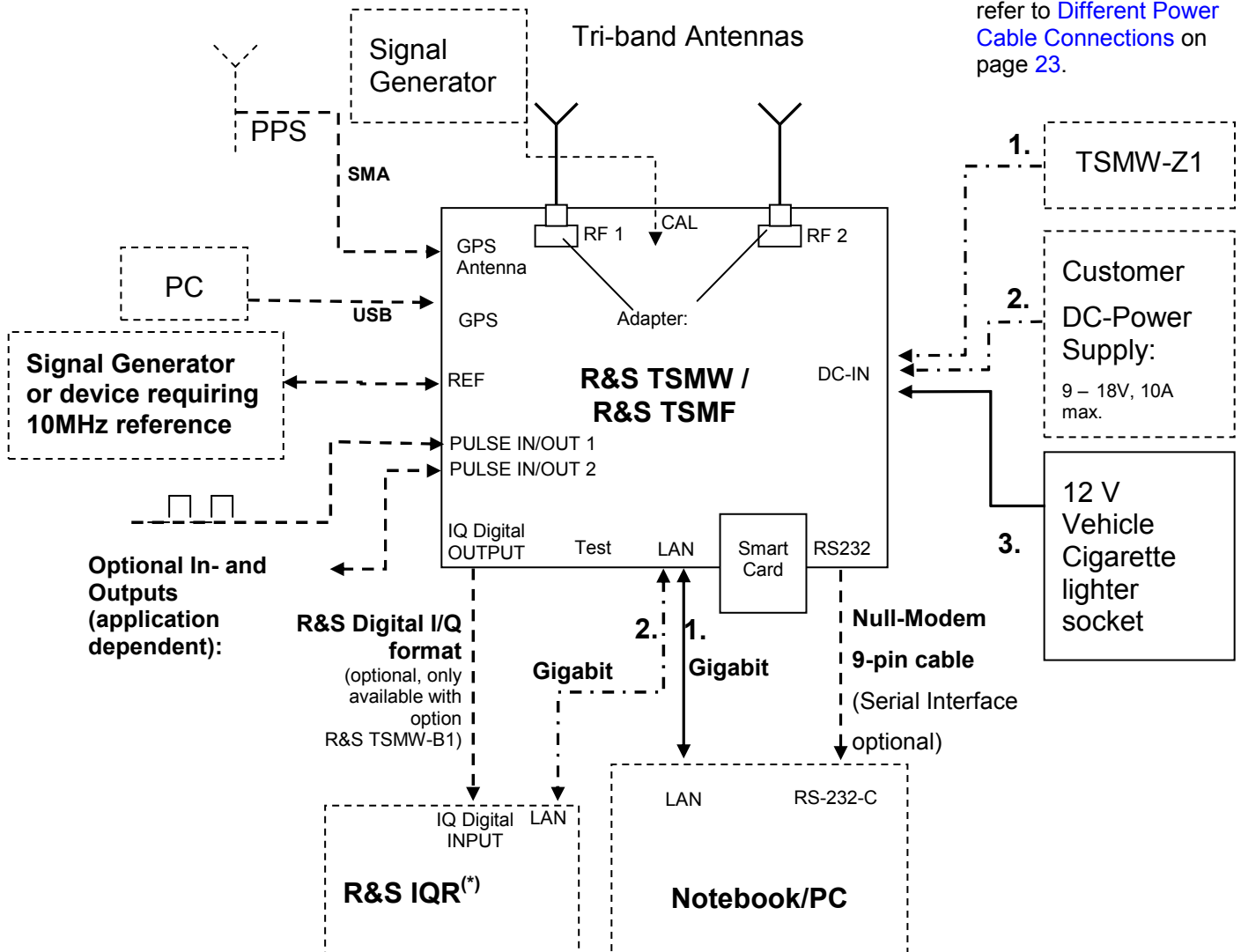

(*) R&S IQR is just an example instrument. The data could be transmitted to any R&S instrument with an digital I/Q IN interface which supports the corresponding transfer mode.

----- cables, not part of the supplied accessories

PPS: Pulse per Second, falling edge with high precision!

Figure 5-1: Wiring Diagram

Connecting the LAN Interface

A LAN cable can be connected to the LAN connector on the rear panel of the instrument. You can use a crossover or straight through LAN cable. There are two methods to establish a LAN connection to the instrument.

- ◆ A dedicated network connection between the instrument and a single computer via an ordinary RJ-45 network cable.
- ◆ A non-dedicated network (Ethernet) connection from the analyzer to an existing network via an ordinary RJ-45 network cable.

NOTICE

Separate Network Interface

Generally we recommend using a separate network interface card with independent LAN connection and deactivated firewall.

Dedicated Network Connection

To establish a LAN connection proceed as follows:

- ◆ Connect an appropriate LAN cable to the LAN port. The chip inside the instrument recognizes which type of connection is used. The system can adapt to 10, 100 and 1000 Mbit/sec and furthermore switch between cross-connected and straight LAN cable.
- ◆ Each instrument has a unique pre-configured IP address: 192.168.0.2.
- ◆ The LAN adapter on the host PC has to be configured in the following way:
 1. Go to the Network Connection Dialog "Start"->"Settings"->"Network Connections".

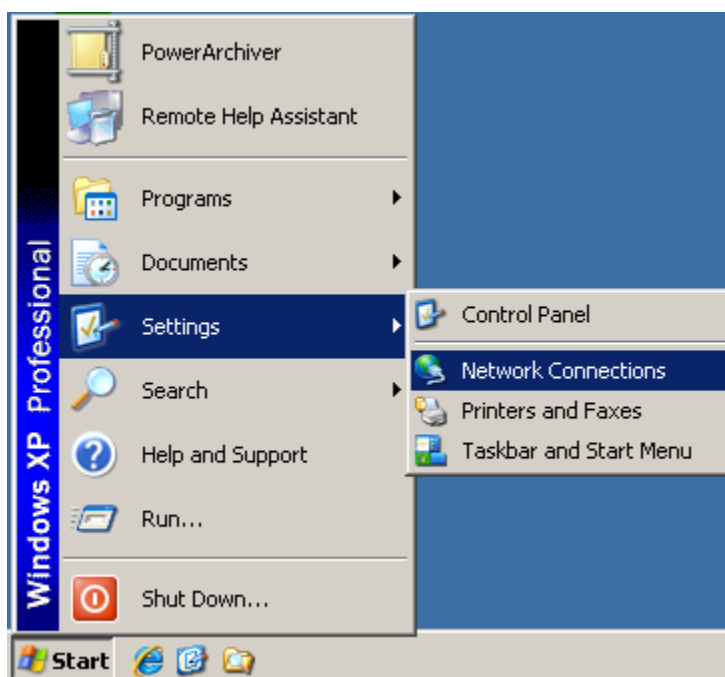

2. Select the LAN Connection which is connected to the instrument and open the "Properties" dialog via right mouse click.

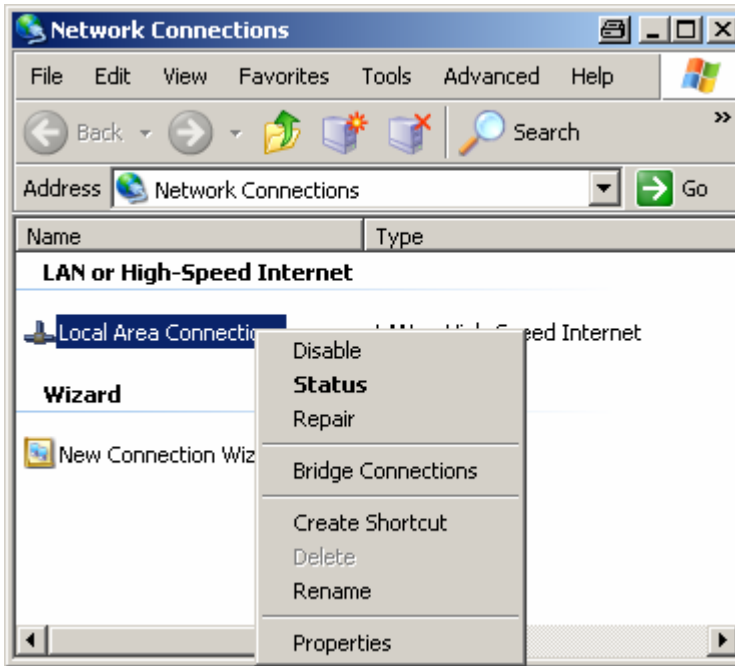

3. Select Properties for Internet Protocol (TCP/IP).

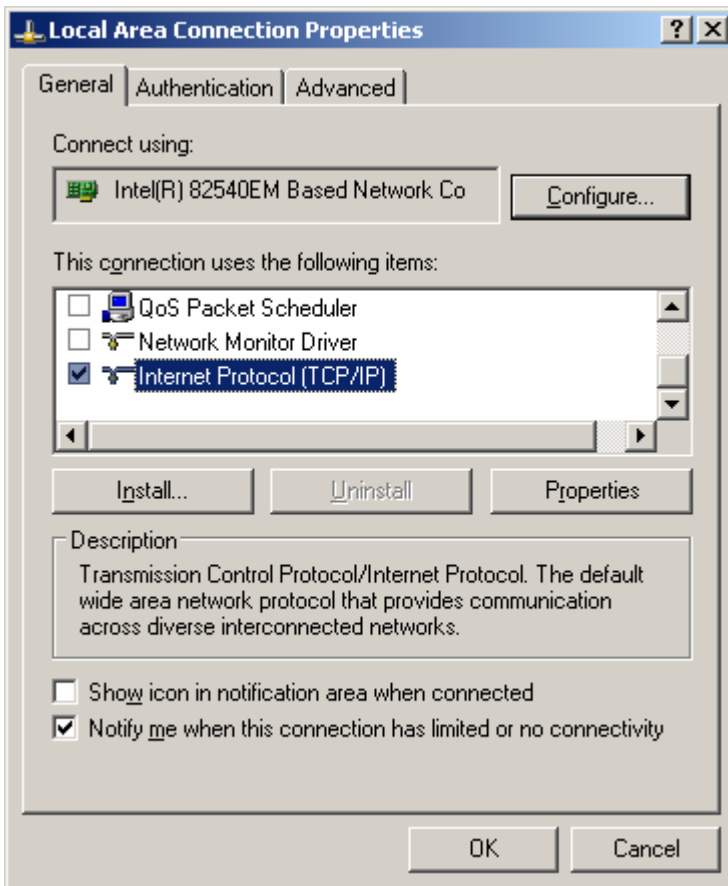

- 4. Use following TCP/IP settings:
 - IP address: 192.168.0.1
 - Subnet mask: 255.255.255.0
 - No Default Gateway

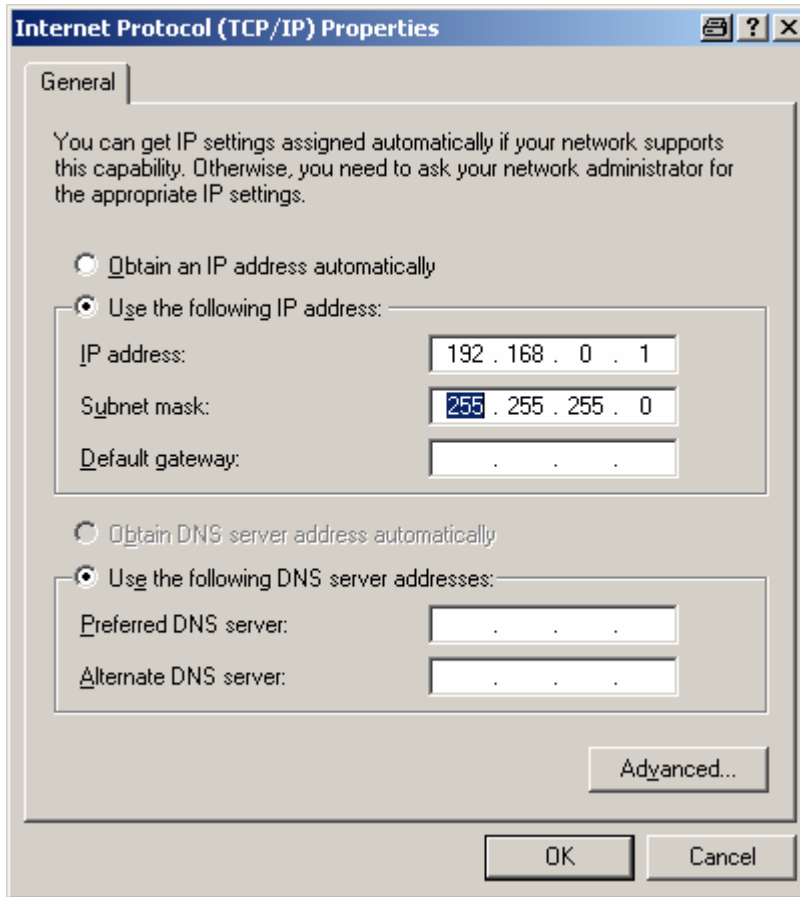

- Open "Advanced Settings" window and deactivate NetBIOS over TCP/IP in the WINS tab.

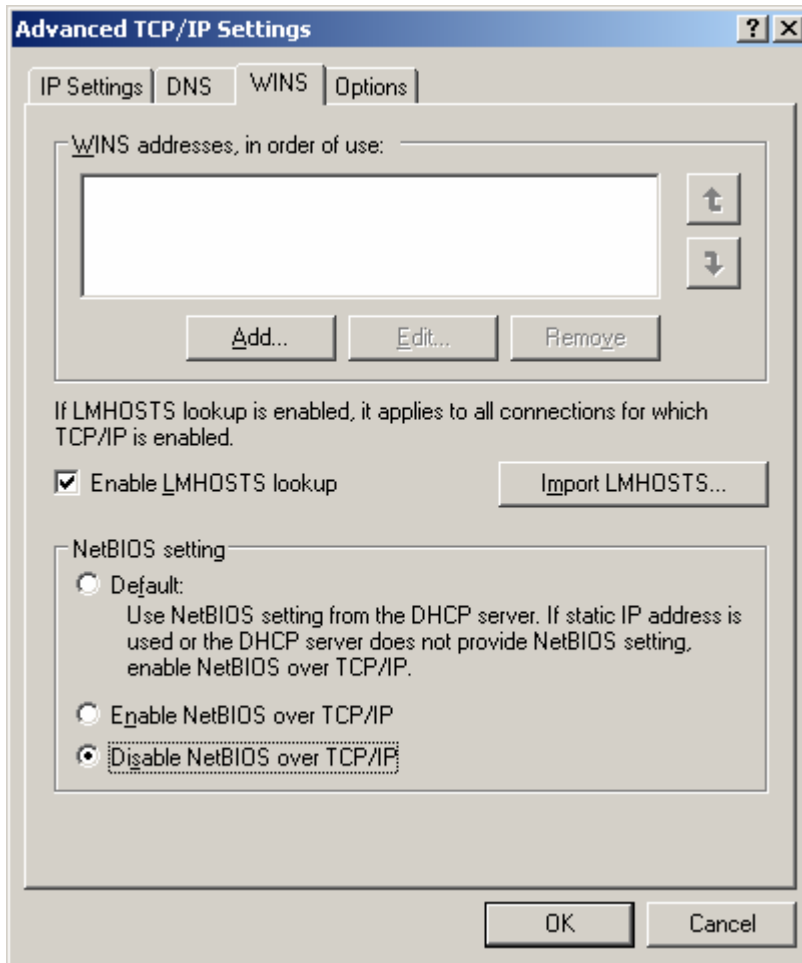

- For optimal data throughput you should open the "device manager".

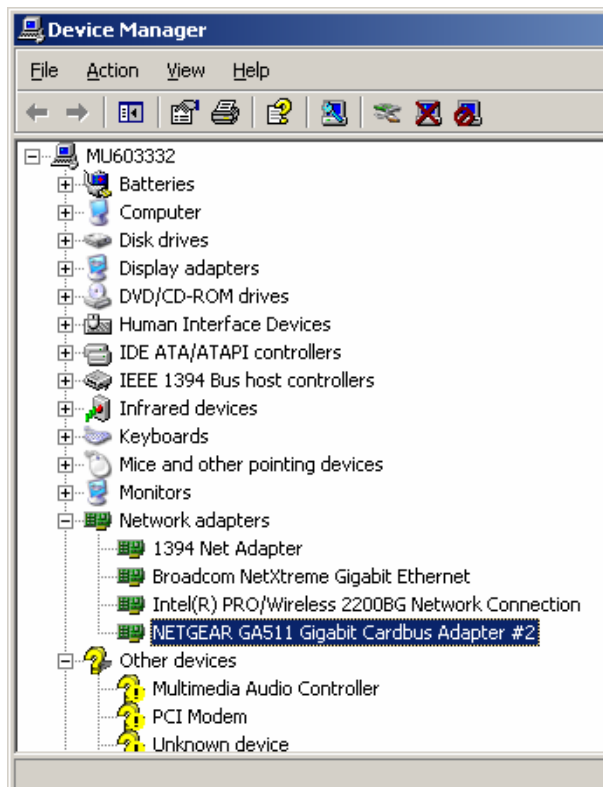

- 7. Enable "Jumbo Frames" with 9k if possible.

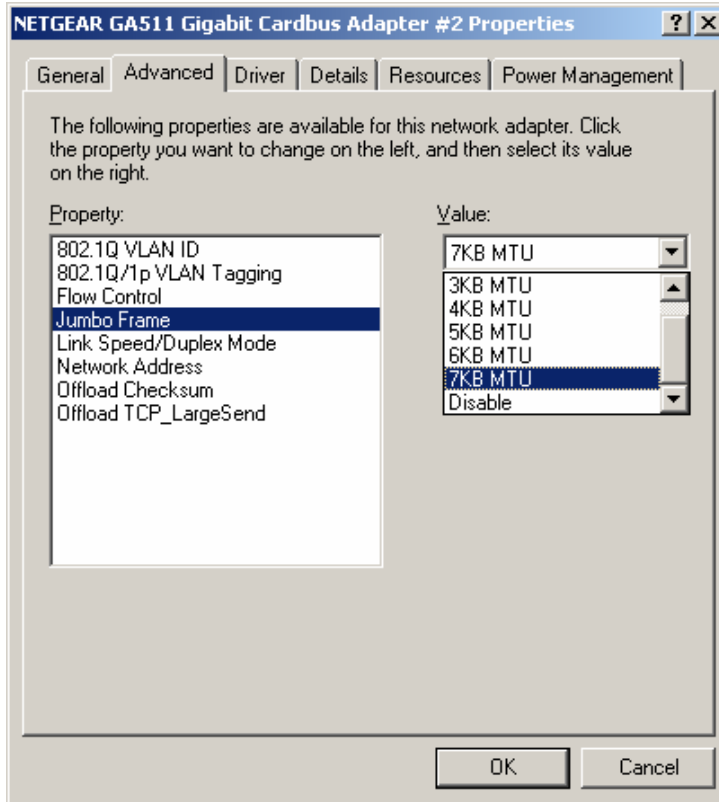

- 8. Enable "Flow Control".

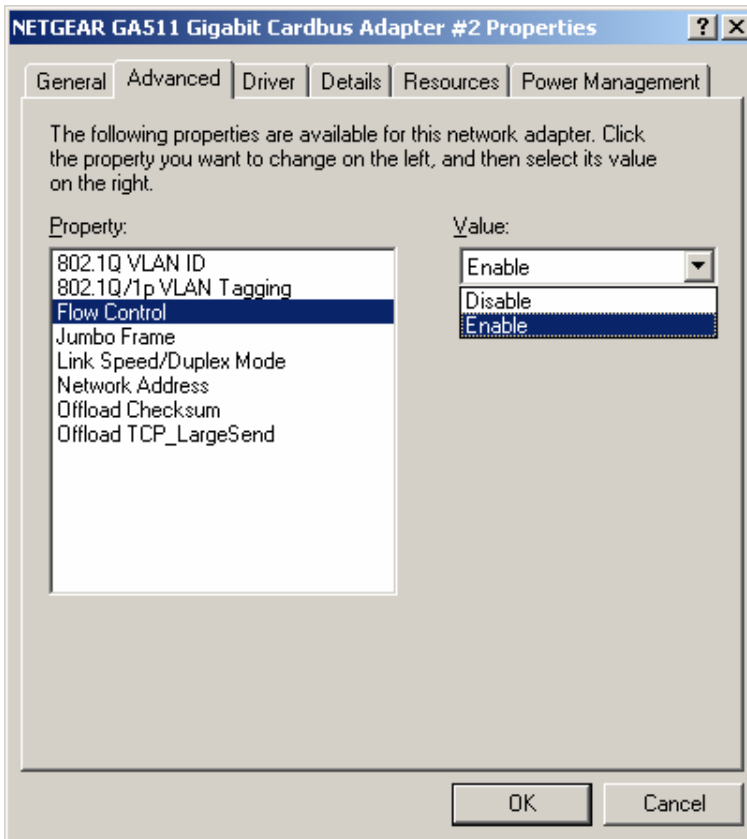

- ◆ After booting the instrument double check via ping command if the connection is successfully established (see [Ping Command](#)).

Non Dedicated Network Connection

If the device operates in a network, the IP address and subnet mask of the instrument must be set up according to the network requirements.

Set the default IP address and subnet mask via the RS232 interface according to the specifications of the network see *Troubleshooting RS232* "Setting the IP address via RS232"

On the host PC the DHCP on the LAN adapter must be turned off!

Then turn off and on the device. Now the device can be addresses with the new specified IP address.

NOTICE**Activate the correct Ports**

If your firewall is active make sure following ports are available:

Port 56026 Data transport between PC and analyzer.

Port 80 HTTP Port for Browser configuration.

Connecting the Instrument to the DC Power Supply

The DC supply connector is at the rear panel of the unit. When the instrument is connected to the DC supply, it automatically sets itself to the correct range for the applied voltage (range: see type label on the rear panel). There is no need to set the voltage manually.

⚠ DANGER**Danger of shock hazard!**

- ◆ After moisture condensation, allow the receiver to dry before switching on.
 - ◆ The device is still power-supplied while it is in standby mode. I.e. switched off with the power button but still connected with the DC Power Supply.
 - ◆ After connecting the Power Supply the device is immediately under power.
 - ◆ The DC-Connector is intended for disconnection.
 - ◆ If another DC Supply than TSMW-Z1 is used:
 - a) Customer DC-Supply shall be in accordance with IEC / EN / UL / CSA 60950-1 or IEC / EN / UL / CSA EN EN61010-1.
 - b) 12V vehicle cigarette lighter socket must be fused.
-

NOTICE**Danger of instrument damage!**

- ◆ Do not cover the ventilation holes.
 - ◆ Connect the receiver only with SELV (Safety Extra Low Voltage) power supplies.
 - ◆ An additional external fuse must be inserted if the DC power supply offers more than 35 A!
 - ◆ Use only EN 60950 approved external DC power supplies
 - ◆ The receiver may be connected only to DC supplies:
DC Input range: 9V to 18 V with 10A max.
-

Rohde & Schwarz offers a compatible power supply, the R&S® TSMW-Z1 (order number 1503.4608.02).

Different Power Cable Connections

1. TSMW-Z1 (order number 1503.4608.02) comes with a ready-made instrument power plug, so the device can be operated directly.
2. The instrument is provided from a proprietary DC supply with the analyzer power cable. For this purpose the cigarette lighter must be demounted and the open ends of the cable must be connected to the customer electricity supply, the polarity has to be respected (see figure below).

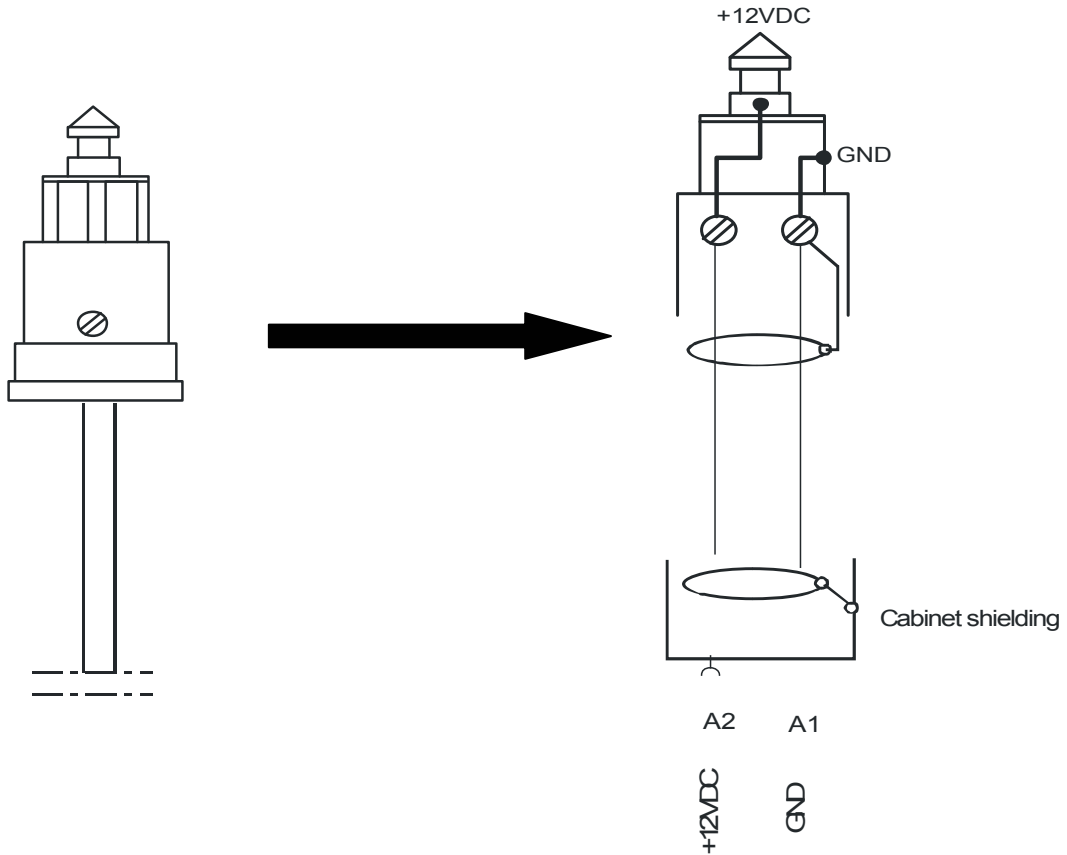

Figure 5-2: Proprietary Power Supply

3. To supply from the cigarette lighter, put the premounted power cable into the car cigar jack. An adapter might be required; it is part of the shipment.

6. Switch On or OFF

Switch On

Starting-up does not require a strict course of action, but we recommend the following sequence:

1. Establish the LAN connection to a PC running with R&S ROMES or Customer Software application via R&S ViCom or R&S TSMW-K1 Digital I/Q interface.
2. Establish the connection to the RF antenna.
3. Establish the connection to the GPS antenna (optional).
4. Connect external devices to the In/Out ports (application specific).
5. Use the supplied power cable to connect the power supply to the instrument.

As soon as you connect the instrument to the power supply, the instrument switches to the operating mode and completes the power on sequence. A self-test is done during the power on sequence. After completing the self-test successfully the PROC STATE LED turns on and will keep it on. In case of a failure during the self test the light starts flashing. After power on the LED CONFIG STATE starts blinking for a few seconds afterwards the light will be keep on.

The power on sequence can be monitored by means of the front-panel LEDs (see [Figure 3-1: Front panel view](#) on page 10 for LED location). Additional information can be seen via the RS-232-C interface (see [Troubleshooting via RS 232](#)).

Table 6-1: Power on Sequence

LED	Color	State	Comment
PWR	green	On	continuously after power on
CONFIG STATE	amber	On	about a second after PWR LED goes on continuously after completion of initialization
PROCESS STATE	green	Off	continuously after power on
PROCESS RUN	green	Off	continuously after power on

After completing the power on sequence, the instrument switches to the idle mode and is ready to be connected by an application.

Switch OFF and Standby Mode

By switching off the instrument with the Power Switch on the front panel the instrument changes to standby mode. The On LED is off and Ext DC LED is illuminated, see [Figure 3-1: Front panel view](#) on page 10. In the standby mode, the program execution on the instrument will be stopped immediately, but the instrument is still under power connection. Pressing the POWER button in the standby mode initiates another power-on sequence (see [Switch On](#) on page 30).

NOTICE**Switch Off**

Do not switch off the instrument while a connection to the application software is being established, otherwise the application might not be able to close properly. As a result, the software could crash and must be shut down from the Windows Task Manager.

7. Checking the Instrument

The analyzer offers the possibility to use a browser based application to check the state and status of the instrument. Also operation and maintenance purposes can be done via the browser. The LEDs on the front panel indicate the state of the instrument as well.

Browser Application

The web interface offers following possibilities:

- ◆ Display of System, Hardware and Firmware Configuration
- ◆ Display of Network Configuration
- ◆ Display of Software Options
- ◆ Installation of new options
- ◆ Firmware Update

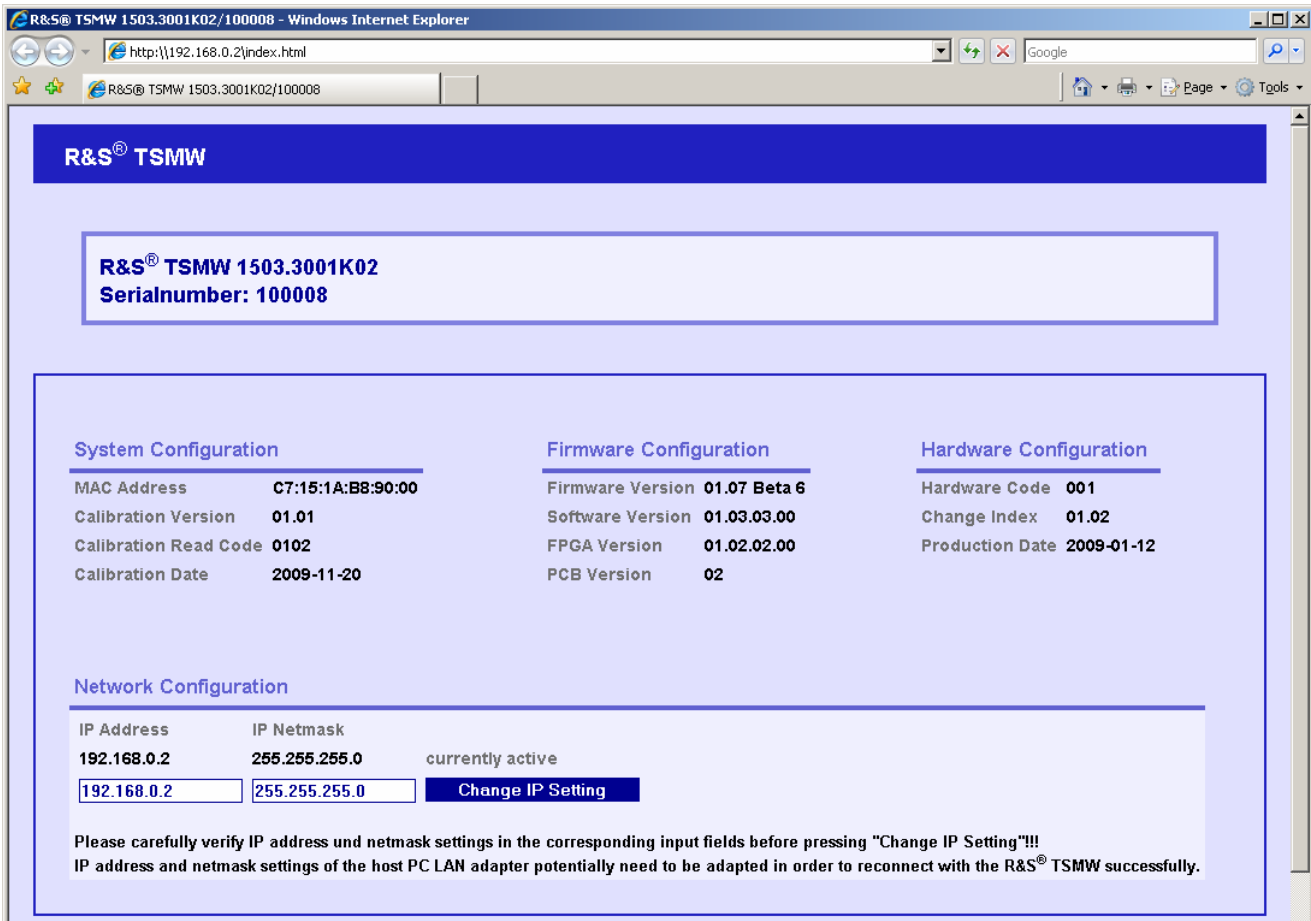

Figure 7-1: Example screen part I: R&S TSMW Browser

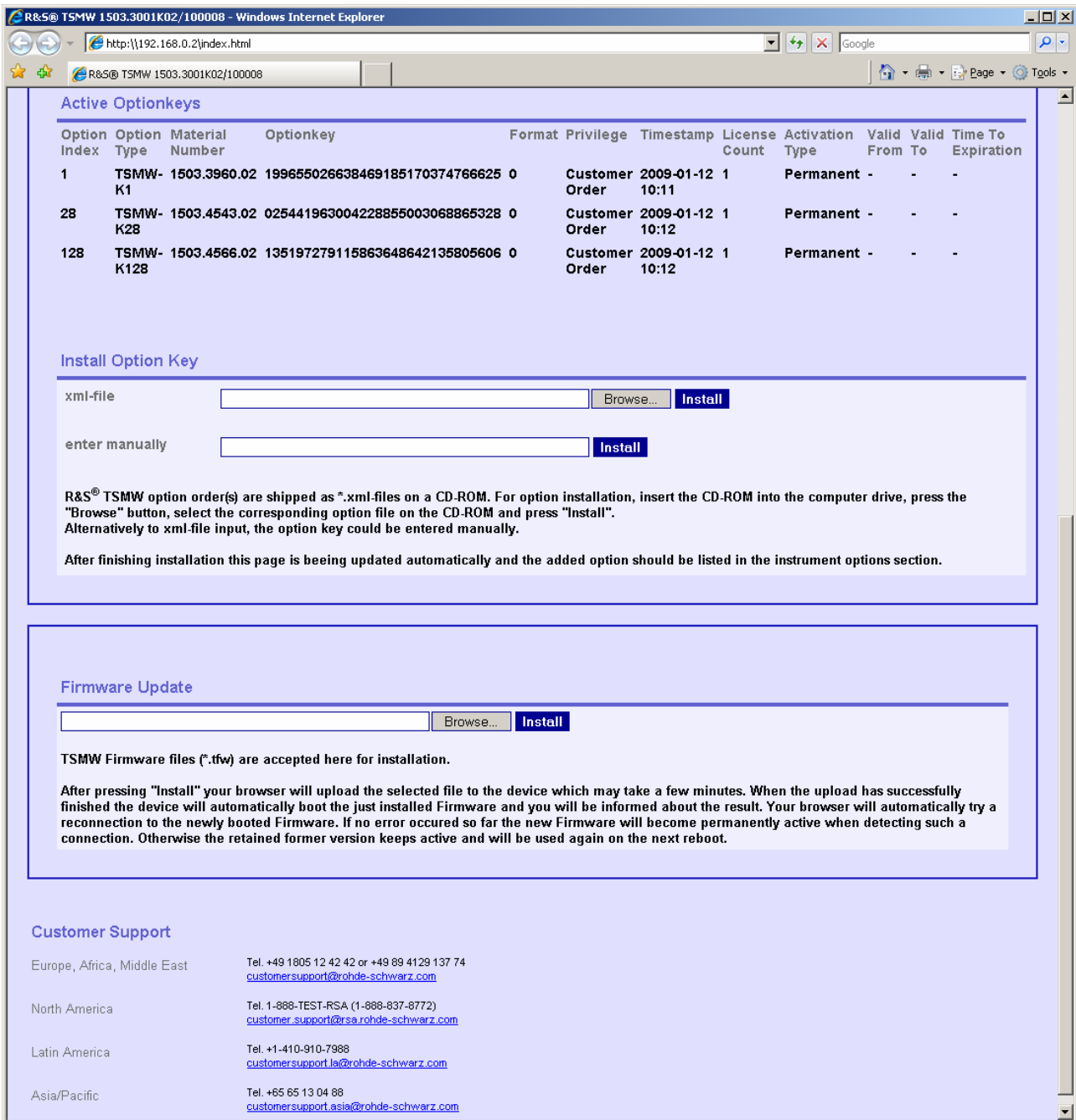

Figure 7-2: Example screen part II: R&S TSMW Browser

Recalling Instrument Setup

Select the instrument home page via the web browser. This page displays all the related instrument data.

- ◆ Hardware State
- ◆ Serial Numbers
- ◆ Firmware Version
- ◆ Calibration Data

Overview Instrument Modes

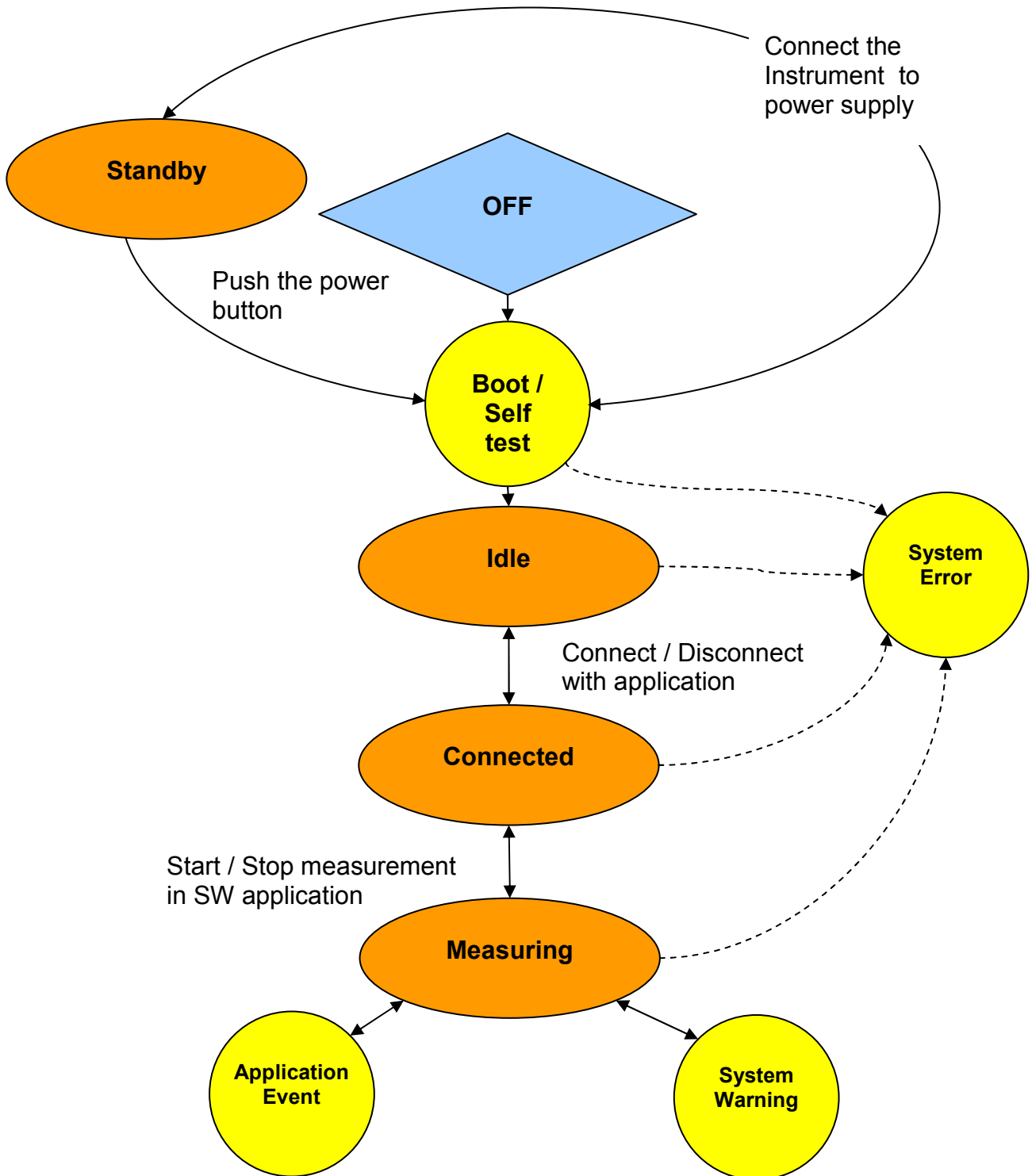

Figure 7-3: Modes and Interim States

Table 7-1: Instrument Modes

	PROCESS STATE	PROCESS RUN	CONFIG STATE	CONFIG ERR
Standby	off	off	off	off
Idle	on	off	on	off
Connected	on	on	on	off
Measuring	on	blinking slowly	on	off
Blinking fast: 4 pulse/sec Blinking slowly: 1 pulse/sec				

Table 7-2: Instrument Interim States

	PROCESS STATE	PROCESS RUN	CONFIG STATE	CONFIG ERR
Boot / Self test	after successful self test on	off	blinking fast; after 2 second on	off
System Warning	blinking slowly	-	-	-
System Error	blinking fast	-	-	-
Application Event	-	blinking fast	-	-
Blinking fast: 4 pulse/sec Blinking slowly: 1 pulse/sec				

Standby Mode

In the standby mode, the program execution on the instrument will be stopped immediately, but the instrument is still under power connection. Only the Ext.DC LED is on.

Idle Mode

The instrument switches to idle mode as soon as booting and self-test has been finished. The PROCESS STATE LED turns on immediately.

Connected Mode

The instrument switches to connected mode as soon as the host PC (R&S ROMES or customer application with ViCom or TSMW-K1) accesses the instrument via the LAN interface and configures the measurement. In connected mode the PROCESS RUN LED turns on. The PROCESS STATE LED is still on.

After finishing the program download and completing some initialization routines the instrument is now ready for R&S ROMES, R&S ViCom or Matlab® originated measurement commands.

Measuring Mode

The instrument switches to measuring mode immediately after receiving any “Start Measurement/Recording” command from the host PC software. For information on how to carry out instrument measurements with R&S ROMES or any programming interface (R&S ViCom, Matlab® or C++), please refer to the *R&S ROMES, R&S TSMW Programming Interface* and the *R&S ViCom Programming Interface* manuals.

The PROCESS STATE LED is on and the PROCESS RUN LED is blinking slowly.

Boot / Self test Mode

This state indicates a couple of processes like booting the software, self test, load main programs and FPGA configuration. Here FPGA (Field Programmable Gate Array) will be configured i.e. FPGA configuration data and primary boot codes are loaded from the flashcard to the FPGA.

System Warning

A temporary problem in the instrument is detected, it is not affecting the measurement e.g. no PPS signal from the GPS or buffer battery low, RF overflow etc. To find out the problem use the RS232 Trace outputs (see [Troubleshooting via RS 232](#)).

System Error

If the instrument indicates “System Error” no measurements are possible. To find out the problem use the RS232 Trace outputs ([Troubleshooting via RS 232](#)).

Application Event

The instrument indicates particular events during a measurement.

8. Basic Instrument Functions

Generally it exists the following possibilities to perform measurements with the analyzer:

- ◆ WiMAX Scanner Application
- ◆ LTE Scanner Application
- ◆ GSM & WCDMA Scanner Application
- ◆ CDMA2000® & 1xEVDO Scanner Application
- ◆ TETRA Scanner Application
- ◆ RF Power Scanner Application

The instrument allows GSM, WCDMA, CDMA2000® 1xEVDO, WiMAX, TETRA and LTE simultaneously. Therefore it offers the wideband RF frontend a maximum measuring flexibility in all frequency bands irrespective of the standard involved.

Refer to the R&S ROMES and R&S ViCom manual for more details.

Moreover, the R&S TSMW can be used as a real time scanner for I/Q baseband data. The *R&S Digital I/Q SW Option* (R&S TSMW-K1) offers a MATLAB® and a C++ interface to measure I/Q data and to transmit and evaluate this data.

The R&S Digital I/Q SW option offers various interfaces for use:

- ◆ R&S Digital I/Q Interface via C ++ (refer to TSMW Interface Programming Manual)
- ◆ R&S Digital I/Q Interface via Matlab® (refer to TSMW Interface Programming Manual)

R&S TSMW-K1 Digital I/Q SW Option

A special asset of the R&S TSMW is its R&S TSMW-K1 Digital I/Q SW Option (R&S TSMW-K1). It provides a data interface application. The application provides flexible a MATLAB® interface as well as an equivalent C++ function interface for performing measurements directly on the R&S TSMW Radio Network Analyzer and processing the results on the PC or another R&S instrument (i.e. transmits the I/Q data over the R&S Digital I/Q Interface to the R&S®IQR). This enables you, for example, not only to design and analyze receiver algorithms in MATLAB®, but also to port them to C++ as a real time version. Or you can even perform technology-independent channel measurements, which can be used to simulate realistic fading scenarios in the lab.

The option offers different I/Q measurement types:

- ◆ **Single measurement**

Performs a single I/Q data measurement.

- ◆ **Periodic measurement**

Performs in equal intervals a single I/Q data measurement.

- ◆ **Stream measurement**

Performs seamless streaming of I/Q data in real time. Therefore a continuous measurement is performed that writes the measured I/Q data into one file until the maximum size is reached. The I/Q data could be streamed over the Gigabit LAN interface or if available the R&S Digital I/Q Interface (R&S TSMW-B1).

The measured I/Q data from a periodic or a single measurements are usually transmitted over the Gigabit LAN interface, since the bandwidth of an ethernet connection is mostly sufficient for the transfer of I/Q data to the destination instrument or host PC.

However for measured I/Q data of a stream measurement the R&S TSMW-B1 is recommended as interface. Hence the interface allows to transmit more I/Q data per second than it is possible for a Gigabit LAN connection. Therefore the R&S TSMW could perform measurements with a higher sampling rate without data loss. For more details refer to the R&S TSMW Interface Programming Manual, chapter R&S TSMW-K1 -> Additional Requirements for I/Q Streaming.



R&S TSMW-K1 Digital I/Q SW Option

The R&S TSMW-K1 is only an OEM. It is not supported by R&S ROMES. The customer needs to develop his own application.

Furthermore R&S TSMW-K1 option is required for activating:

- ◆ I/Q data streaming over Gigabit LAN and
 - ◆ I/Q data streaming over R&S TSMW-B interface.
-

Requirements for R&S TSMW-K1 (Matlab®)

- ◆ Matlab® Release 2007/2008B
- ◆ R&S TSMW-K1 Installation (CD-> Applications -> TSMW-K1) on host PC
- ◆ R&S TSMW-K1 Option on R&S TSMW
- ◆ Gbit LAN interface (only for I/Q baseband streaming, otherwise 100 Mbit LAN sufficient)

Requirements for R&S TSMW-K1 (C++)

- ◆ R&S TSMW-K1 Installation (CD-> Applications -> TSMW-K1) on host PC
- ◆ R&S TSMW-K1 Option on R&S TSMW
- ◆ Gbit LAN interface (only for I/Q baseband streaming, otherwise 100 Mbit LAN sufficient)

Preparations

Please refer to the R&S TSMW-K1 description in the *R&S TSMW Interface Programming* manual.

Matlab® Functions

If the m-files are located in the current working directory, the appropriate action will be executed by retrieving a function with the corresponding parameters:

```
[outputvalue1,outputvalue2,...]=function_name(inputvalue1,inputvalue2,...);
```

For detailed explanation please refer to the *R&S TSMW Interface Programming* manual.

R&S TSMW-B1 Digital I/Q Interface

Due to its... higher transmission bandwidth, the Rohde & Schwarz I/Q Interface (R&S TSMW-B1) enables I/Q streaming with max. 2×20 MHz bandwidth.

I. e. the R&S TSMW is directly connected with the R&S IQR and operates via the R&S@IQR touch screen. The I/Q data stored on the removable hard disks of the R&S@IQR can be output to a host PC via Gigabit Ethernet for offline analysis. All Rohde & Schwarz instruments with a Rohde & Schwarz I/Q interface, e.g. a signal generator, can be connected via the digital I/Q interface.

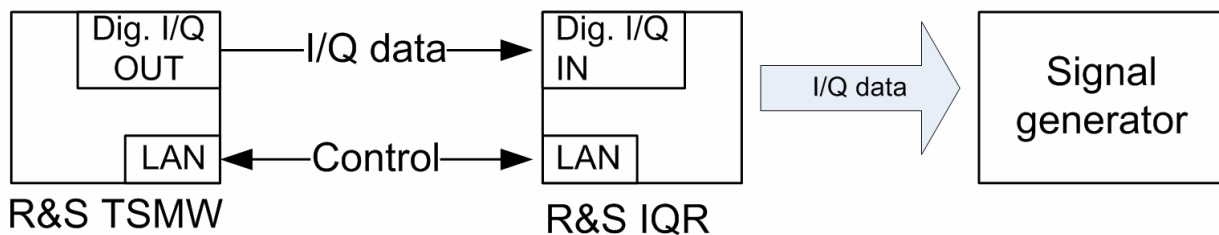

Figure 8-1: Example setup: Measure(R&S TSMW) – Transfer (R&S TSMW) – Record (R&S IQR) – Replay (R&S IQR)

Transfer Mode

The data transfer mode controls the flow of measured I/Q data over the R&S Digital I/Q Interface. The transfer mode is automatically communicated to the destination instrument using the control lines of the interface; there is no need to adjust any settings at the destination instrument.

The R&S TSMW always uses transfer mode 1 for data transmitting. Transfer mode 1 is supported by all Rohde & Schwarz instruments which are equipped with the R&S Digital I/Q Interface.

Requirements for R&S TSMW-B1

- ◆ R&S TSMW-K1 Installation (CD-> Applications -> TSMW-K1) on host PC or destination instrument
- ◆ R&S TSMW-K1 Option on R&S TSMW
- ◆ Gbit LAN Interface (100 Mbit LAN sufficient)
- ◆ The destination instrument has a R&S Digital I/Q interface and support transfer mode 1.

Preparations

Please refer to the Digital I/Q interface application (R&S TSMW-K1) in the R&S TSMW Interface programming manual.

R&S ViCom Programming Interface

General

R&S ViCom interface is a software package to develop software applications which integrate the analyzer as an OEM product into customer software.

The R&S ViCom package, which is part of the shipment, need to be installed on the host PC and includes documentation and sample applications.



Scanner Options

Interfacing the analyzer via the R&S ViCom interface requires the availability of corresponding scanner options on the instrument. Open the instrument web browser to see the installed scanner options.

Refer to:

- ◆ [Table 9-2](#): on page 52
 - ◆ Chapter [Browser Application](#) on page 32
-

Requirements

- ◆ The corresponding scanner option is installed on the instrument.
- ◆ The R&S ViCom software interface package is installed on the host PC.

Installation

The setup program including sample applications and documentation is located in the CD-ROM subdirectory `..\ applications\ViCom`.

The latest ViCom version could be downloaded from the product homepage in the internet under: <http://www.rohde-schwarz.com> – Section Download/Software.

R&S ViCom can be installed in parallel to previous versions. If this is not required to uninstall previous versions in Windows XP.

The setup program could be started directly from the CD-ROM by running the `setup.exe` file in this subdirectory.

When starting the setup program a dialog comes up to enter the target directory. The default location for the ViCom interface package is: `..\RuS\ViCom<version no.>`.



Adapt target drive

It is recommended not to change the target directory for the R&S ViCom installation but only to adapt the target drive.

In the next step the setup program will transfer the complete R&S ViCom interface package to the host PC. Close this setup program after finishing the file transfer.

The ViCom installation adds a shortcut entry in the Windows start menu
"Rohde & Schwarz -> ViCom <version no.>" from where you have a convenient access to all
the R&S ViCom specific data (demo applications, debug utilities, tools and manuals, etc.).

Scan Options for R&S ROMES and ViCom

The analyzer can be customized by using various options. Together with the R&S ROMES or the ViCom software, different technologies can be used with the instrument and displayed via the R&S ROMES software at the same time, while the hardware resources can be scaled however needed.

- ◆ Parallel support of multiple wireless communications technologies
- ◆ Measurements are possible simultaneously in GSM, WCDMA, CDMA2000® 1xEVDO, WiMAX, TETRA and LTE
- ◆ Calculation of base station locations from scanner measurements via R&S ROMES software plus GPS position measurements plus high accuracy PPS.
- ◆ Power Scans over the entire frequency range from 30 MHz to 6 GHz.
- ◆ Simple scanner setup
- ◆ Flexible assignment of the two receivers for maximum measurement speed

Requirements for R&S ROMES

- ◆ R&S ROMES Installation (refer to R&S ROMES manual).
- ◆ R&S ROMES Option on Dongle (refer to [Table 9-2](#): on page 52).
- ◆ SW Option R&S TSMW-K2x installed on the analyzer (refer to [Table 9-2](#): on page 52).

Preparation for R&S ROMES

Start the R&S ROMES software application after the power on sequence has been completed (see [Table 6-1: Power on Sequence](#) on page 30). The instrument application program will be downloaded from the host PC either during R&S ROMES software start or while loading the instrument software driver in R&S ROMES. This depends on the availability of an R&S ROMES option dongle.

Please refer to the R&S ROMES software manual for details. For information on how to configure and carry out R&S ROMES and analyzer measurements, please refer to the R&S ROMES manual either.

Requirements for R&S ViCom

- ◆ R&S ViCom Installation (refer to R&S ViCom manual).
- ◆ SW Option R&S TSMW-K2x installed on the analyzer (refer to [Table 9-2](#): on page 52).

R&S TSMW-K21 GSM & WCDMA Option

The R&S TSMW-K21 option enables the functionality to use the instrument as GSM and WCDMA scanner. With the option the instrument could measure and identify all WCDMA and GSM downlink (Node B and BTS) signals in the air. The main purpose of these

measurements is to test the receiving conditions of a mobile device in a WCDMA or a GSM network and to analyze possible interferences. Furthermore the measured spectrum analysis consists of a frequency sweep over a specified range to detect arbitrary WCDMA downlink and uplink signals. Results of the WCDMA and GSM scans are displayed in R&S ROMES within the corresponding PNS views.

R&S ROMES supports as from version 4.30 this scanner option.

R&S TSMW-K22 CDMA2000® 1xEVDO Option

The R&S TSMW-K21 option enables the functionality to use the instrument as CDMA2000® 1xEVDO scanner. Hence the instrument could measure and identify all CDMA2000 downlink (BTS) signals in the air.

R&S ROMES supports as from version 4.30 this scanner option.

R&S TSMW-K26 TETRA Option for R&S ROMES

The R&S TSMW-K26 option enables the functionality to use the instrument as TETRA scanner. With the option the instrument could measure and identify all TETRA downlink (BTS) signals in the air. The main purpose of this measurement is to test the receiving conditions of a mobile device in a TETRA network and to analyze possible interferences and find possible gaps in the coverage. Results of the TETRA scans could be displayed in R&S ROMES within the corresponding PNS views.

R&S ROMES supports as from version 4.40 this scanner option.

R&S TSMW-K27 RF Power Scan Option

The R&S TSMW-K27 option enables the functionality to use the instrument as power scanner. With the option the instrument could measure throughout the entire frequency range from 30 MHz to 6 GHz. As a result, mobile radio bands as well as the uplink ranges can be measured, and detecting interference on the uplink frequencies becomes very easy. Results of the RF Power scans could be displayed in R&S ROMES within the corresponding RF Power Scanner Spectrum view.

R&S ROMES supports as from version 4.50 this scanner option.

R&S TSMW-K28 WiMAX Option

The R&S TSMW-K28 option enables the functionality to use the instrument as WiMAX scanner. With this option the instrument detects each and every available WiMAX signal with sensitivity below the noise level. Therefore it can check neighborhood information, and also identify interference signals from remote base stations. This option allows together i.e. with R&S ROMES to detect and visualize basic parameters such as FFT size, length of cyclic prefix and frame rate, preamble ID and the cell ID as well as the segments used in the

WiMAX signal. At the same time, it calculates the RSSI and the CINR based on the preamble. It provides the user with an overview of the actual situation on the air interface. Incorrect configurations in the network such as preamble IDs used more than once on the same center frequency in neighboring cells, different cycle prefix lengths or unexpectedly poor CINR values despite high RSSIs can thus be detected immediately. R&S ROMES supports as from version 4.10 this scanner option.

R&S TSMW-K29 LTE Option

The R&S TSMW-K29 option enables the functionality to use the instrument as LTE scanner. TDD and FDD technologies are supported. Furthermore:

- ◆ Automatic detection and measurement of P-SCH and S-SCH channels
- ◆ Easy detection of interference
- ◆ Cyclic prefix analysis with a channel impulse response measurement

The option is useful i.e. to roll out and optimize 3GPP EUTRA networks.

R&S ROMES supports as from version 4.30 this scanner option.

GPS Standalone via USB

Prerequisite for the GPS Standalone operation is, that the internal GPS receiver is not used by R&S ROMES resp. R&S ViCom or R&S TSMW-K1 software.

The USB connection (port GPS) to the PC must be established and the USB antenna must be connected (GPS port ANT).



GPS Standalone

The "Standalone" operation is only necessary if the instrument is not acting with the R&S ROMES / ViCom software or a firmware update of the GPS receiver is necessary.

From the R&S ROMES / ViCom software the GPS module is accessible via the LAN interface and the USB connection is not necessary.

When connecting the USB port the first time Windows is looking for the applicable driver.



The applicable driver is delivered with the CD, insert the CD and select *Search removable media floppy*.

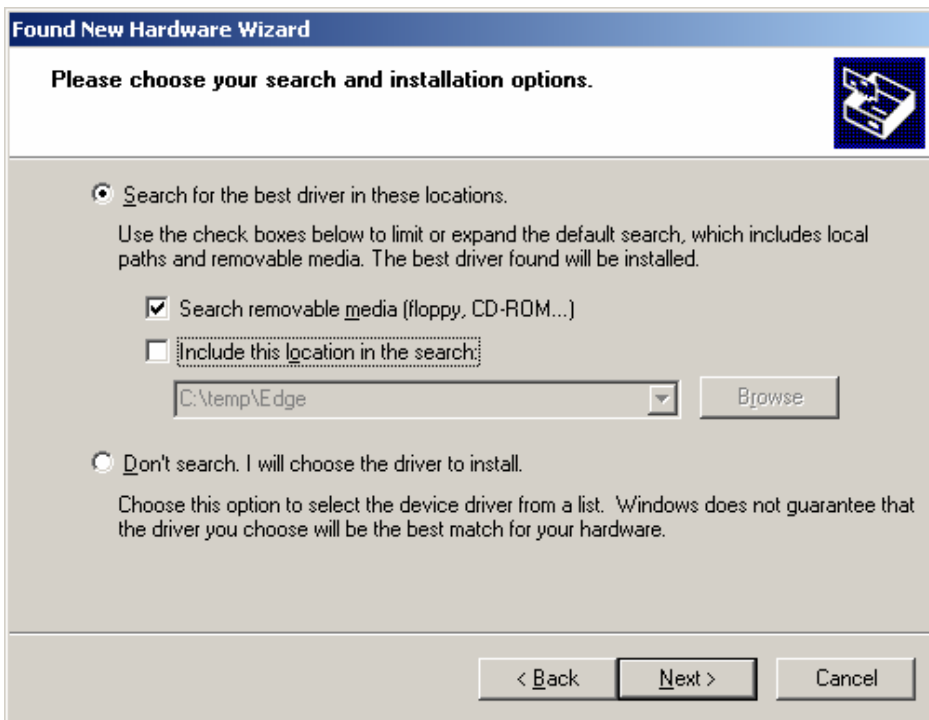

If the appropriate driver is chosen press *Finish*.

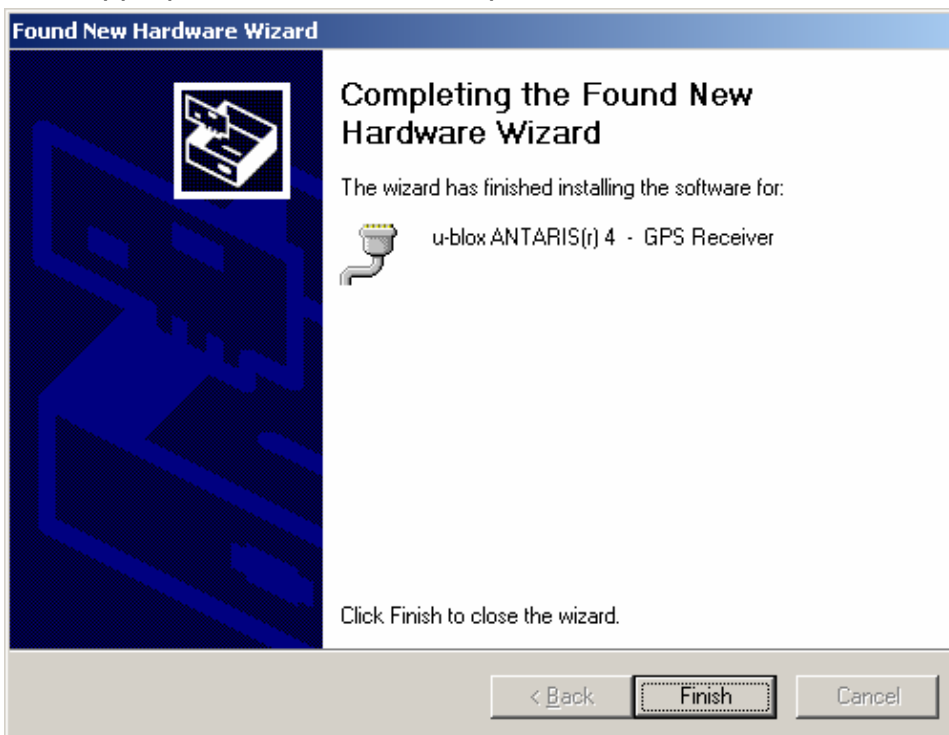

After successful installation you can find in the Device Manager> Control Panel following entry: ANTRARIS(r) 4 associated with the emulated COM port.

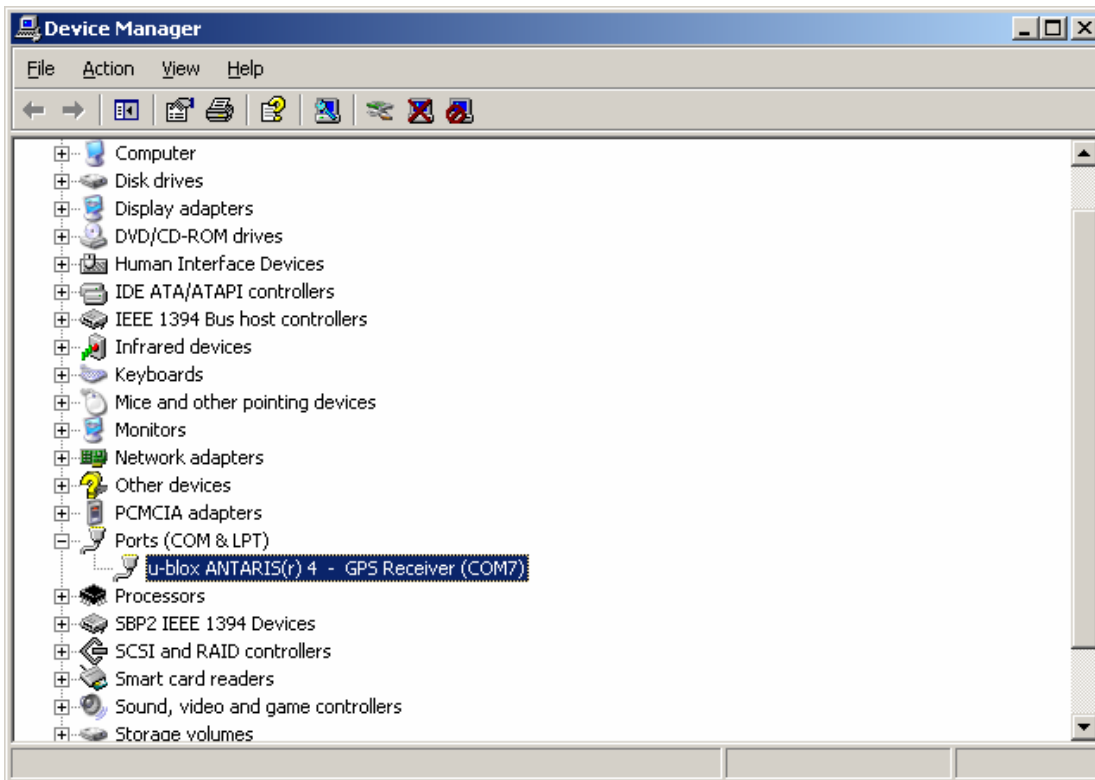

Any terminal program, which is connected with this COM interface, can access GPS data in NMEA format.



u-Blox

The module is using the u-Blox LEA-4H chipset. For further details and applications, contact the manufacturer uBlox www.u-blox.de.

Example with Windows Hyper Terminal

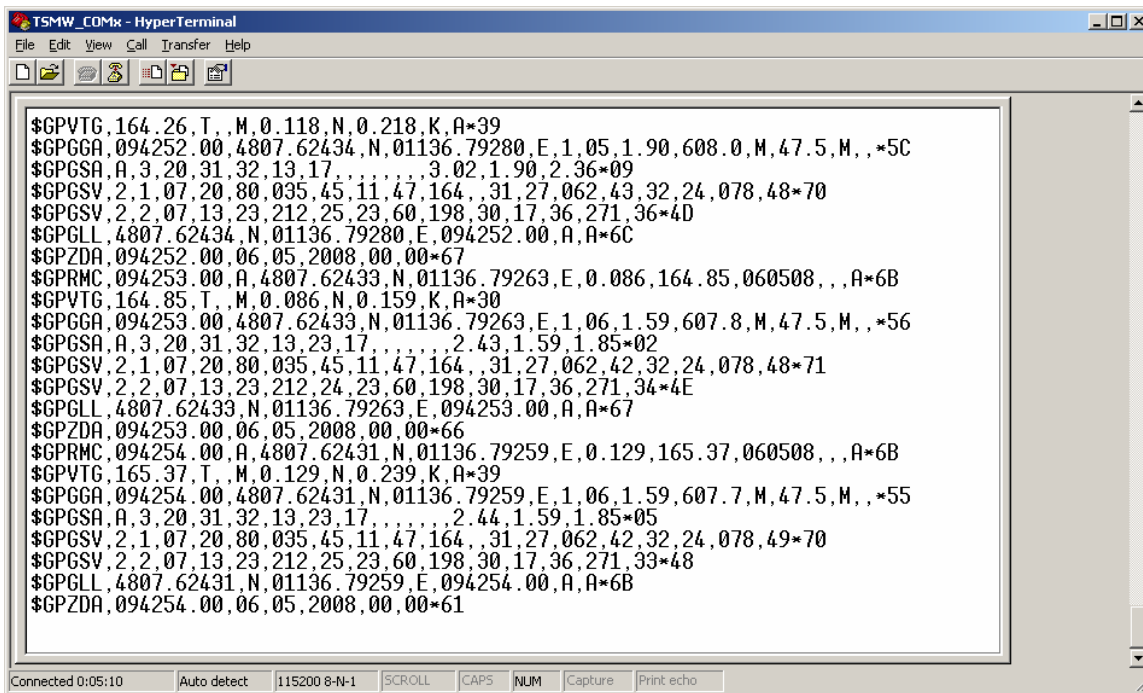
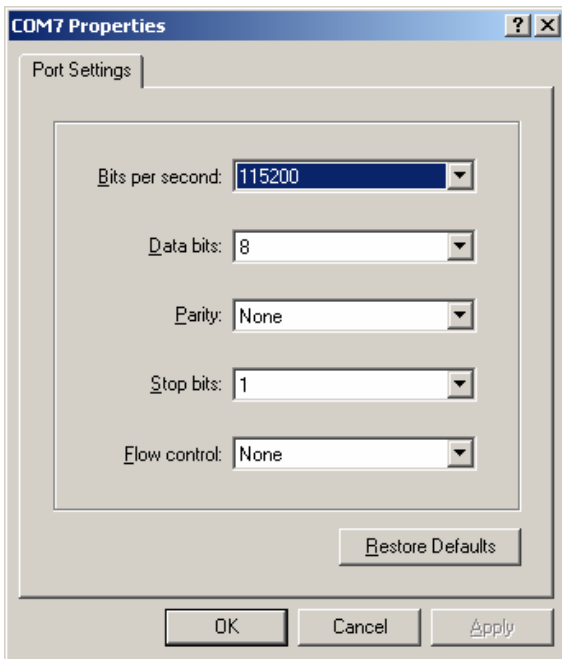

9. Installed SW

Option Key

The web browser is used to see the system information. Furthermore you can recall the instrument setup (see page 33) and install new options.

Program Requirements to install the Option Key

- ◆ PC/notebook with the instrument option CD or optional an internet connection
- ◆ PC/notebook with LAN interface
- ◆ PC/notebook and the instrument is connected with the accessory LAN cable
- ◆ The instrument is in idle mode (see [Overview Instrument Modes](#) on page 34)
- ◆ No other software application interfacing with the instrument.

Software Options

In general software options consist of more than one single option key, see [Table 9-2:](#) on page 52. Always all option keys of the software option have to be installed on the instrument for proper use.

E. g: Software option R&S TSMW-K28:

The software option R&S TSMW-K28 – WiMAX Scanner Application consists of the following two keys:

- ◆ **R&S TSMW-K128**
Activate the WiMAX technology on the instrument.
 - ◆ **R&S TSMW-K28**
Activate the interface for the WiMAX technology on the instrument.
- The two keys have to be installed on the instrument for full functionality.
- ◆ Additionally the corresponding R&S ROMES option ROMES4T1W has to be enabled on the R&S ROMES software dongle (only needed for R&S ROMES support).

Installation of Software Options

The software options for instrument upgrade are shipped as XML files. They are provided on a separate CD-ROM or optional the software option is provided as zip file and could be downloaded from the R&S ftp server. Software options are installed via the instrument web browser application (via "Options" area). For installation details see the installation instruction which is provided with the shipped XML files.



Software Options

All new devices are preconfigured and software options are already installed. Only for additional reorders you have to enable the software options with the adequate option keys.

For details about the software options see the following tables.

Table 9-1: Option for R&S TSMW interface programming

Option	Option Keys (XML files)	Order No.
TSMW-K1 Digital I/Q SW Option	TSMW-K1	1503.3960.02

Table 9-2: Scan Options for R&S ROMES and ViCom

Option	Option Keys (XML files)	Order No.
TSMW-K21 GSM & WCDMA Scanner Option	TSMW-K21 TSMW-K121 TSMW-K221	1503.4514.02
TSMW-K22 CDMA & EV-DO Scanner Option	TSMW-K22 TSMW-K122 TSMW-K222	1503.4520.02
TSMW-K26 TETRA Scanner Option (only supported for R&S ROMES)	TSMW-K26 TSMW-K126 TSMW-K1	1510.8792.02
TSMW-K26Q TEDS Scanner Option (only supported for R&S ROMES)	TSMW-K26Q	1510.8792.02
TSMW-K27 Spectrum Scanner Option	TSMW-K27 TSMW-K127	1503.4537.02
TSMW-K28 WiMAX Scanner Option	TSMW-K28 TSMW-K128	1503.4543.02
TSMW-K29 LTE Scanner Option	TSMW-K29 TSMW-K129	1503.4550.02
TSMW-K30 LTE MIMO Option	TSMW-K30	1514.4085.02

To use the scan options with R&S ROMES, R&S ROMES has to be enabled. Therefore install the option ROMES4T1W on the R&S ROMES dongle to enable R&S ROMES for the R&S TSMW scan options.

Ordering Additional Software Options

Orderings for option upgrades require that you supply the serial number of the instrument. As return the required option keys are provided on a separated CD ROM.

If you ordered software options for several instruments it is optional possible that they are provided via download from R&S ftp server. For more details about the ftp download, please contact your R&S service center.

10. Maintenance

Firmware Update - TSMW

A firmware update is supported as a stand-alone tool with the name **tinstaller.exe**. It can be started via the command line. Also the browser is used to update the instrument firmware. The GUI is interactive and guides you through the entire firmware update process.

NOTICE

Danger of instrument damage!

Make sure that neither R&S ROMES nor any other utility tool interfaces with the instrument at the same time. Shut down any active utility before starting the browser!



Release Notes

Please refer to the firmware information provided in the internet for installer utility details and new features with each version. Upload the required firmware version from the R&S homepage www.rohde-schwarz.com. Go to TSMW and then to the Download Area.

Requirements

- ◆ PC/Notebook with LAN interface
- ◆ PC/notebook and the instrument is connected with the accessory LAN cable.
- ◆ RS-232 interface (COM1) of PC/notebook and the instrument is connected via a null-modem cable (see
- ◆
- ◆
- ◆ RS-232-C Output on page 62 for terminal settings).
- ◆ The instrument is powered up and power on sequence completed successfully (see [Switch On](#) on page 30).
- ◆ No other application access the instrument in the same time.

Instructions FW Update via Web Browser

- ◆ Download the current instrument firmware of your version of the product and store it locally on the hard drive, take care of the Release Notes **TSMW.tfw**.
- ◆ Connect your PC/notebook to the instrument via the LAN interface.
- ◆ Make sure that neither R&S ROMES nor any other utility tool interfaces with the

instrument at the same time.

- ◆ Open the web browser on the host PC and enter the IP address. The instrument web interface will pop up.
- ◆ Go to the "Firmware Update" area and click the button "Browse".
- ◆ Select the file you stored in the beginning.
- ◆ Click the "Install" button.
- ◆ The new firmware file will be saved in the system. This will take some seconds, do not disturb this progress.
- ◆ After finishing the download progress the instrument web interface will be updated. After successful refresh of the web interface the new firmware will be activated.
- ◆ If the refresh is not done successfully the device will activate the previous firmware version with the next reboot.



Firmware Update

The duration of the firmware download will be indicated via a status bar and the LEDs of the devices.

-
- ◆ Immediately after the reboot of the instrument click the refresh button of the web browser. An acknowledge button appears.
 - ◆ Within 5 seconds click the button to confirm the installation of the new firmware version.



Reactivate the original firmware version

If the confirm button is not pressed or not pressed within the timeframe of 5 seconds, the original firmware version will be reactivated.

Configure IP Settings

Devices are preconfigured with the default IP address 192.168.0.2 and subnet mask 255.255.255.0. The IP address and subnet mask can be changed with the web interface to the required settings for the network. The configuration can also be queried and changed via the RS232 interface. To adopt the new settings the system needs a restart.

Generally we recommend using a separated network interface card, see [Connecting the LAN Interface](#) on page 22.

IP Configuration via the Web Browser

- ◆ Start the web browser and enter the new IP address in the appropriate fields.
- ◆ Click "Change IP Settings".

Network Configuration

IP Address	IP Netmask	
192.168.0.2	255.255.255.0	(currently active)
<input type="text" value="192.168.0.2"/>	<input type="text" value="255.255.255.0"/>	<input type="button" value="Change IP Setting"/>

Please carefully verify IP address und netmask settings in the corresponding input fields before pressing "Change IP Setting"!!!
IP address and netmask settings of the host PC LAN adapter potentially need to be adapted in order to reconnect with the R&S® TSMW successfully.

The old and also the new IP address and subnet mask after rebooting will be shown.

Network Configuration

IP Address	IP Netmask	
192.168.0.2	255.255.255.0	(currently active)
192.168.0.4	255.255.255.0	(currently configured, active after next reboot)
<input type="text" value="192.168.0.4"/>	<input type="text" value="255.255.255.0"/>	<input type="button" value="Change IP Setting"/>

Please carefully verify IP address und netmask settings in the corresponding input fields before pressing "Change IP Setting"!!!
IP address and netmask settings of the host PC LAN adapter potentially need to be adapted in order to reconnect with the R&S® TSMW successfully.

- ◆ Trigger a reboot and access the instrument web interface with the new IP address.

Network Configuration

IP Address	IP Netmask	
192.168.0.4	255.255.255.0	(currently active)
<input type="text" value="192.168.0.4"/>	<input type="text" value="255.255.255.0"/>	<input type="button" value="Change IP Setting"/>

Please carefully verify IP address und netmask settings in the corresponding input fields before pressing "Change IP Setting"!!!
IP address and netmask settings of the host PC LAN adapter potentially need to be adapted in order to reconnect with the R&S® TSMW successfully.

IP Configuration via RS232

Changing the IP Setting via the RS232 is exceptionally necessary if wrong *Settings* are done via the web interface and the instrument is not accessible any more.

- ◆ Enter the command `ipconfig` to see the current IP settings.
- ◆ With `ipconfig [IPv4Address] [IPv4Netmask]` you can change the address.
 - IPv4Address (Format 123.456.789.012)
 - IPv4Netmask (Format 123.456.789.012)

Firmware Update – GPS Receiver

Under normal conditions there is no need to update the firmware of the internal GPS receiver. The instrument is shipped with an appropriate firmware version.

Only with the newer generation of the R&S TSMW (hardware code 001 – see [Identifying the Hardware Revision](#)) it might be necessary to upgrade the instrument firmware in order to use GLONASS.

During the firmware update, no other software application (R&S ROMES, R&S ViCom, R&S TSMW-K1) should interface with the GPS receiver (see [GPS Standalone via USB](#)).

The firmware of the GPS receiver could only be updated via the USB port using the tool provided by u-Blox for this purpose.

The tool is called 'u-Center'.

Please see the appropriate software annual for further details.

Further information can be obtained from the u-Blox website: www.u-blox.com

11. Troubleshooting

Identifying the Hardware Revision

The current hardware revision can be identified via the following steps:

- ◆ Start a browser and open the TSMW HTML page
- ◆ Look at the 'Hardware Configuration' information (top right)
- ◆ Check the 'Hardware Code' entry in this list

If the Hardware Code has the value '000':

- ◆ This instrument does not support the REF output function
- ◆ This instrument can not use GLONASS or Galileo

If the Hardware Code has the value '001' or higher:

- ◆ This instrument supports the REF output function
- ◆ This instrument is equipped with an LEA-6H GPS engine and supports GLONASS* or GALILEO.

NOTE: A firmware update of the embedded GPS receiver might be necessary to support this feature.

Self test of the RF chain

This test is used to verify the complete HF chain in the instrument. The test can be triggered via the command line for later releases also via the instrument web interface.

- ◆ Connect the test output and the RF1 or RF2 with the corresponding cables.
- ◆ Establish a terminal connection via RS232.
- ◆ perform `rf_selftest [1: RF1 / 2: RF2]`
- ◆ Await the test result. The result is "passed" or "failed".
- ◆ Connect the test cable to the other RF port.
- ◆ perform again `rf_selftest [1: RF1 / 2: RF2]`
- ◆ Await the test result. The result is "passed" or "failed".

Identifying Error State via Front Panel LEDs

The following LEDs on the front panel indicate an error (see [Figure 3-1: Front panel view](#) on page 10):

Table 11-1: Error LEDs

LED	Color	Behavior	Error	Description
ERROR BAT	Yellow	On	Low Battery	Battery level is low.
ERROR PWR	Red	On	Power failure	At least one internal voltage rail is out of tolerance.
ERROR TEMP	Red	On	Temperature Failure	Temperature inside the device is too high.
ERROR RF OVR	Red	On	RF Overflow	RF Input is too high at the antenna connectors
CONFIG ERR	Red	On	Configuration State failure	Data on flash card is invalid or program error
CONFIG ERR	Red	Flashing	Configuration State failure	No flash card inserted in flash card slot

Troubleshooting Errors Indicated by LEDs

RF Error

If the RF input is too high for the front ends, the signal overdrives and can't be processed any more. If the RF OVR LED turns on, you should immediately turn down the RF Input. If the LED is still illuminated the unit must be switched off and the RF Input signal strength must be measured and corrected. The device is not protected against destruction by over modulation.

Temperature Error

The electronic equipment in the radio network analyzer is protected against thermal destruction. If the temperature inside the analyzer exceeds a specific limit, the unit changes to the TEMP ERROR mode and switches off the main voltages. The ventilation runs another 15 sec then also the LEDs turn off.

To switch the unit to Standby Mode again, press the POWER button.

If the temperature error occurs repeatedly within the operating temperature range, please make sure that the air can really escape freely through the vents at the sides on the left and the right. If the air circulation is guaranteed and the failure remains constant, return the device to Rohde & Schwarz service.

Config Error

The instrument configuration data and the boot sequence are read from the internal compact flash (CF) card. If the CONFIG ERROR LED indicates “Flash Card Missing” (LED blinking fast) immediately after the analyzer has been powered on, the configuration data cannot be read from the CF card.

If the CONFIG ERR LED indicates “Flash Card Error” (LED on), the flash card may also contain erroneous or corrupt files. After five seconds indicating a Configuration Error the device will switch to Standby mode.

The reason for the Flash Card Error during ordinary R&S ROMES measurements is usually a program failure in the instrument itself. At this stage, the instrument will no longer respond to the R&S ROMES application. You can check this by monitoring the RS-232-C output (see Tracing R&S ROMES Measuring mode) and the PROCESS LEDs on the front panel (see R&S ROMES Measuring mode). If an error occurs, the blinking of the LEDs stops!

In this case, shut down the R&S ROMES application from the Windows Task Manager and reset the instrument. Wait for the instrument to complete the power on sequence and then set up a new R&S ROMES measurement.

If the error persists, contact Rohde & Schwarz support.

NOTICE**Device Warranty!**

You will lose any kind of warranty if you open the cover of the flash card on the rear panel and remove the flash card.

For information on how to perform R&S ROMES measurements, refer to the R&S ROMES documentation.)

Power Failure

At least one internal voltage rail is out of range. Return the device to Rohde & Schwarz service.

Guide to solving Instrument Connection Problems

The following flow-diagram enables a systematic check of the LAN connection to the instrument when the initial connect fails:

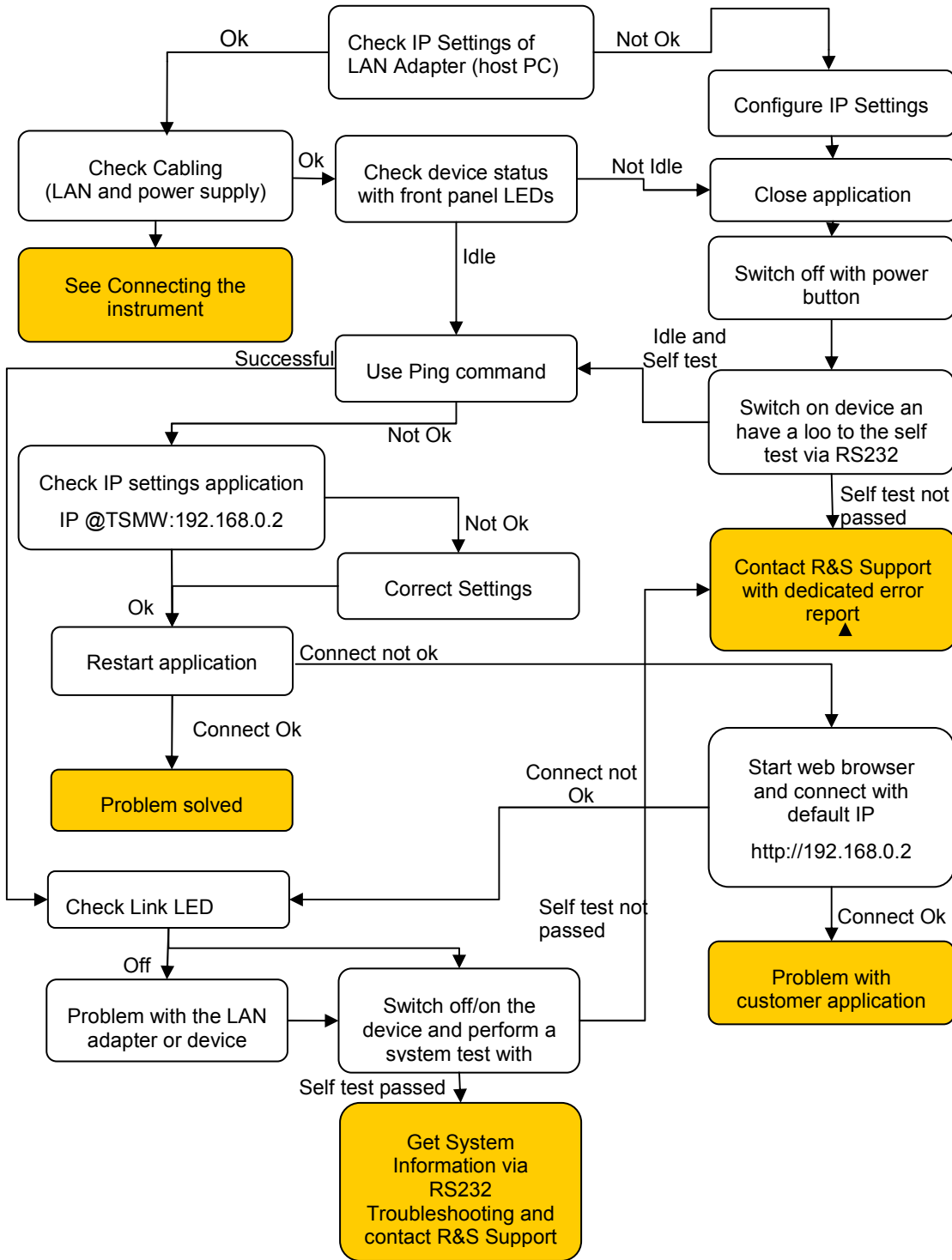
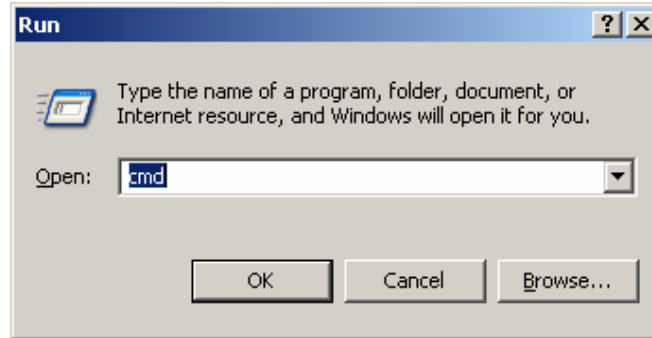

Figure 11-1: Troubleshooting: LAN Connection

Ping Command

The ping command can be used to check the LAN connection to the instrument.

- ◆ Open the command line: Start->Run



- ◆ Type in the command `ping 192.168.0.2` and wait for the answer.

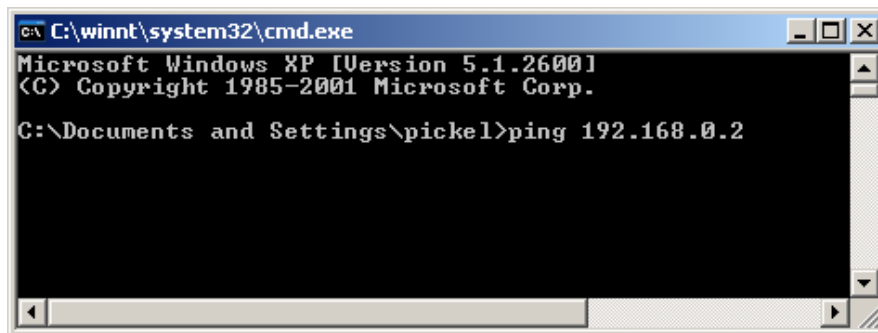

The answer should look approximately like this one – i.e. a list of Ping reply times. If not there is a connection problem (see [Guide to solving Instrument Connection Problems](#)).

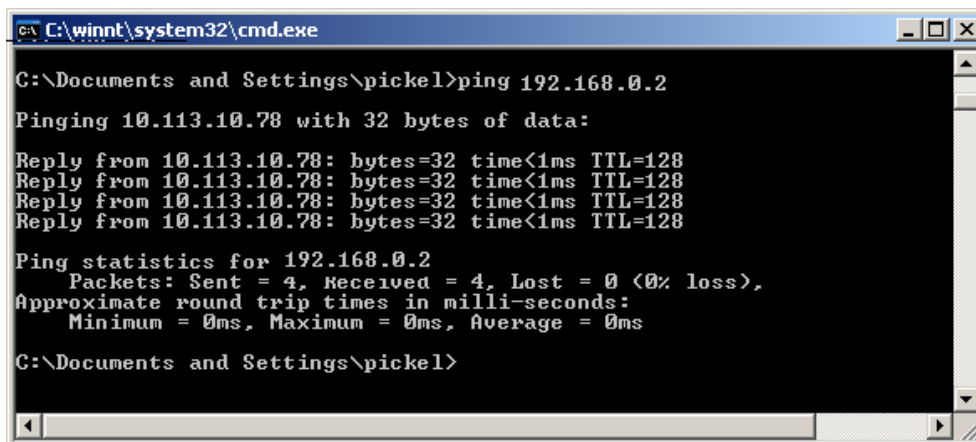

Troubleshooting via RS 232

Monitor the status information outputted on the serial interface to check whether the instrument is in running order.

After installing the R&S TSMW-K1 option two new links will appear in the start menu:

- ◆ TSMW Hyper Terminal (Default COM x)
- ◆ TSMW Web interface with default IP address (192.168.0.2)

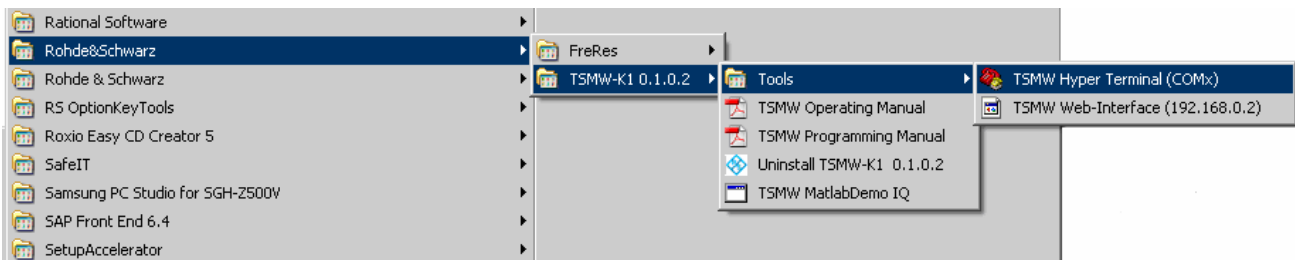

Figure 11-2: Start Menu

RS-232-C Output

During start up and normal operation the instrument outputs status information via the RS-232-C connector on the rear panel parallel with standard communication via the LAN interface. Monitoring the output information on the serial interface does not decrease the analyzer's performance in any manner, but is always a valuable tool to verify the analyzer's current state.

To display the status information on the computer, the following steps are necessary:

1. Connect a serial 9-pin null modem cable between the RS-232-C socket of the analyzer and the serial interface of your PC.
2. Set up a terminal program connection on your computer's RS-232-C interface with the following settings:

Bits per second:	115200
Data bits:	8
Parity:	no parity
Stop bit:	1
Flow control:	no flow control

3. Start the terminal session

Tracing Power On Sequence

If the unit is in Standby mode, press the power button. The following listing should appear on the "Hyper Terminal" screen (see [Listing 1: Terminal output during power on sequence](#) on page 64):

NOTICE**Danger of instrument damage!**

Be sure that neither the R&S ROMES software nor the instrument update program or customer application communicates with the instrument at this test.

If the output corresponds with *Listing 1*, then the network analyzer has completed the power on sequence successfully and is ready for the application program download via the LAN interface.

```

-- TSMW Boot: GB v0.1.0.1 [build Apr 28 2008 - 07:31:27]: CTRL-FPGA v0.0.15 PCB rev.2 CF v0.1 --
Performing MPMC Check                : PASS
Loading '\bin\cfg1\Gigabit.elf' ...

Request status from AL-PPC            : PASS
Communication link test GB_PPC - AL_PPC : PASS
Request status from FE-PPC            : PASS
Communication link test GB-PPC - FE-PPC : PASS
Communication link test FE-PPC - AL-PPC : PASS
Read FE ELF-file                      : PASS
Send ELF to FE-PPC (ELF size: 280884 byte) : PASS
Frontend.elf received and unpacked    : PASS
FE-PPC program start                  : PASS
Read AL ELF-file                      : PASS
Send ELF to AL-PPC (ELF size: 208768 byte) : PASS
Analyzer.elf received and unpacked    : PASS
AL-PPC program start                  : PASS

TSMW SW started - final verdict       : PASS

TSMW System Configuration:
-----

TSMW Device ID      : 24:97:1a:02:00:00
Serial number       : 100006
Material number     : 1503.3001
Variant number      : 2
KMat                : Yes
MAC Address         : 00:90:b8:18:73:bb
IPv4 address        : 192.168.0.2
IPv4 netmask        : 255.255.255.0

Preselector installed : YES
Frontend 1 installed  : YES
Frontend 2 installed  : YES

```

Listing 1: Terminal output during power on sequence

If the output corresponds with *Listing 1* the network analyzer completed the power on sequence and is ready for the application program download via the LAN interface.

12. Index

- 1xEVDO, 44
- Antennas, 7
- B1, 40
- Boot / Self test mode, 36
- Browser Application, 32
- Calibration, 17
- CDMA2000, 44
- Cigarette Lighter, 29
- Cleaning, 19
- Configuration, 59
- Connected mode, 36
- DC IN, 15
- DC Power Supply, 28
- Dedicated Network Connection, 22
- Device manager, 25
- Digital I/Q Interface, 40
- Digital I/Q OUT, 16, 40
- Electrostatics, 18
- EMC, 19
- Ext. Ref, 15
- Firmware Update, 53
- Flash Card, 59
- Flow Control, 26
- Front Panel, 10
- GPS, 16
- GPS Antenna, 16
- GSM, 43
- Idle mode, 35
- IP address, 22, 24
- Jumbo Frames, 26
- LAN Interface, 16, 22, 60
- LEDs, 10, 30, 58
 - Configuration, 13
 - Error, 12
- Ext DC, 11
- GPS PPS, 12
- On, 11
- Process, 13
- LTE, 45
- Measuring mode, 36
- Modes, 35
- Network Interface Card:, 8
- Non Dedicated Network Connection, 27
- Option Key, 51
- Option list, 52
- Overview, 5
- Power Cable Connections, 29
- Power On Sequence, 30, 63
- Power Scan, 44
- Prerequisites, 7
- Proprietary DC Supply, 29
- Pulse, 16
- R&S ROMES, 43
- Rack, 9
- Rear Panel, 14
- RF Signal, 17, 20, 58
- RS 232 Interface, 62
- RS232 Interface, 15
- Safety Instructions, 18
- Self Test, 17
- Setting up, 9
- Smart Card, 15
- Software Options, 51
- Standby mode, 31, 35
- System Configuration, 33
- System Error, 36
- System Requirements, 8
- System Warning, 36

TCP/IP settings, 24

Temperature, 58

TETRA, 44

Transfer Rate Hard disk, 8

TSMF, 6

TSMW Modes, 35

WCDMA, 43

WiMAX, 44

Wiring Diagram, 21